

*emotion of sauna.*

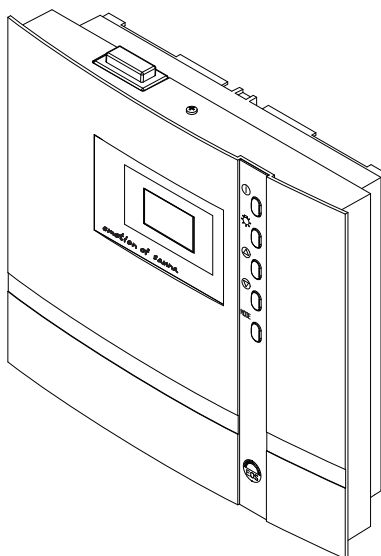

# ECON H1



**GB** Assembly and operating instruction

Made in Germany

**CE** IP x4

## Table of Contents

Standard delivery .....	4
Technical data .....	4
General information concerning sauna bathing .....	5
General safety precautions .....	6
Installation of the control unit .....	7
Wall mount fixture .....	7
Wall mounting .....	7
Wall recessing .....	8
Connecting the sensor cables .....	9
Installation of the heater sensor .....	9
Electrical connection .....	11
Connecting the sauna heater .....	11
Connecting the vaporizer .....	11
Connecting the sauna lamp .....	11
Connecting a fan .....	11
Installation diagram .....	12
Terminal arrangement on the circuit board .....	12
Connecting the sauna heater (max. 9 kW) .....	13
Connection of vaporizer .....	13
Operation .....	14
General .....	14
The user interface .....	14
Operating buttons .....	14
Default display Stand-by .....	15
Default display in operation .....	15
Energy-saving display .....	15
Cabin lighting .....	16
Initial commissioning .....	17
Change language .....	18
Change time .....	18
Activating the Life - Guard .....	19
Activate / deactivate the child lock .....	20
Switching on the sauna unit .....	20
Switching off the sauna unit in the Finnish mode .....	20
Switching on the sauna unit with Life - Guard .....	21
Individual settings .....	22

Cabin temperature .....	22
Humidity operation .....	23
Humidity intensity .....	24
Switching off the sauna unit during humidity operation .....	25
Auto-Stop .....	26
Life - Guard .....	28
Unit fuses .....	29
Error messages .....	30
The device switch (Switch-off) .....	31
Service Address: .....	32
Guarantee .....	32
Handling procedures for return shipments (RMA) - Details for all returns ! .....	33

## Standard delivery

(subject to changes)

Included in control unit scope of delivery:

1. Circuit board for heater sensor with over-temperature protection, KTY-sensor with sensor housing, two mounting screws 3 x 25 mm and sensor cable approx. 2.0 m long.
2. Plastic bag containing three mounting screws 4 x 20 mm.
3. Spare over-temperature protection

## Technical data

Nominal voltage:	400 V 3 N 50 Hz AC
Switching capacity:	max. 9 kW ohmic load (AC1 - operation) Humidity operation: 6 kW + 3 kW for evaporator device
Heating time limitation:	6 h
Display:	Touch display 40 x 21 mm
Dimensions (HxWxD):	220 x 250 x 67 mm
Type of protection:	IPx4 acc. EN 60529 weatherproof protection
Control range sauna operation:	30 to 115 °C
Control range humidity operation:	30 to 70 °C
Humidity control:	time-proportional
Sensor system:	KTY-sensor with safety-temperature limiter 142 °C
Water level monitoring:	After 2 minutes, a water deficit causes the sauna to switch off.
Control characteristics:	Digital two-step control
Ventilator performance:	max. 200 W max. 1 A
Light:	max. 100 W
Reheating:	20 min. after disconnecting the humidity program
Ambient temperatures:	-10 °C to +40 °C
Storage temperatures:	-20 °C to +70 °C

## General information concerning sauna bathing

Dear customer,

with purchase of this sauna control unit you opted for a superior quality, high-tech electronic device which was developed and manufactured according to the highest standards and guidelines.

Please note that an optimal interaction of sauna cabin, sauna oven and sauna control unit is mandatory for a pleasant sauna climate in your cabin.

With this superior sauna control unit you can „operate“ your sauna system, and thanks to the many individual programming settings you will surely soon find the setting that suits you best.

Perception in the sauna is very subjective, therefore it really requires your own perception, or that of your family to find the most suitable settings.

By default the finnish sauna is preset to 95°C. For steam operation the values are set to 60°C and 60% humidity.

The following operation instructions describe how to pre-select „your“ climate in the cabin. Read these instructions carefully, so that you quickly and easily find your way through the programming process.

Please note the variation in temperatures in the cabin while sauna bathing. The hottest area is directly under the cabin ceiling, whereas there is a steady temperature gradient towards the floor of the cabin. Inversely, the relative humidity is lowest directly under the cabin ceiling and the highest on the cabin floor.

For safety reasons the temperature sensor with the overheat safety shutdown is located on the cabin ceiling above the oven, since this is the hottest area in the cabin.

Therefore there will always be temperature variations between the temperature sensor of the control unit and the thermometer in the cabin.

For the cabin light use only light bulbs. Do not use fluorescent lamps, energy saving lamps and gas discharge lamps.

For example, when pre-setting the cabin temperature to 100°C, the thermometer inside the cabin may easily show 85°C - 90°C. This complies with the typical climate inside the cabin.

Always observe hygiene. Always use hand- or bathing towels, to avoid getting perspiration on the wood.

To protect your cabin from possible damages due to steam operation, we recommend reheating or drying the cabin after every steam bath.



In addition, a fan can help to dissipate used humid air in badly ventilated areas.

To avoid the perception of draft, you should avoid using any ventilation system while sauna bathing. It should only be used if recommended by the cabin manufacturer



**Always make sure no objects are located on the sauna oven before starting the heating cycle.**

## General safety precautions

- his device has not been designed for being used by persons (including children) that are physically or mentally handicapped or have sensory disabilities. Moreover, it is not allowed to use this device without sufficient experience and/or knowledge, unless these persons will be supervised by persons responsible for their security or in case they have been instructed how to use this device.
- Children are to be supervised in order to make sure that they do not play with this device.
-  Attention: It is forbidden to install the control box in a closed switch cabinet or behind a wooden panelling!
- The electrical installation may be done only by a qualified electrical technician.
- You must comply with the regulations of your power supply company and applicable VDE regulations (DIN VDE 0100).
-  **WARNING:** Never attempt repairs or installations yourself, as this could result in serious injury or death. Only a qualified technician may remove the housing cover.
- Please note the dimensions in the assembly instructions, especially when installing the temperature sensor. The temperature above the oven is critical for the temperature setting. The temperature can be held within operating parameters and a minimal temperature gradient inside the bench area of the sauna cabin can be achieved only if unit is assembled correctly.
- The device may only be used as intended as a control unit for sauna ovens up to 9 kW. (Up to 36 kW when combined with a breaking capacitor).
- Completely disconnect the control unit from the electrical circuit, i.e. flip all circuit breakers or the main circuit breaker during each installation or repair.
- Please note the safety and installation information from the sauna oven manufacturer.
- Always heed the specifications and instructions of the cabin manufacturer, too.



### Attention!

**Dear customer,**

**according to the valid regulations, the electrical connection of the sauna heater and the control box has to be carried out through the specialist of an authorized electric shop**

**We would like to mention to the fact that in case of a warranty claim, you are kindly requested to present a copy of the invoice of the executive electric shop.**

# Installation of the control unit

## Wall mount fixture

The control unit may only be mounted outside the cabin. It is advisable to select the outside wall of the cabin to which the sauna heater is fixed from the inside as mounting position. If ductwork is already provided for electrical installations then the position of the control unit is predetermined by that. Please follow the instructions for installation:

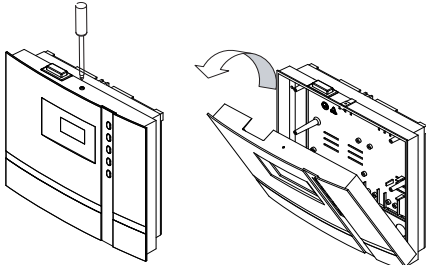

Fig. 1

Remove the control device cover. In order to do this loosen the screw at the top of the housing and pull the housing top upward while swivelling (Fig. 1).

## Wall mounting

1. The 3 mm diameter boreholes for the supplied wood screws 4 x 20 mm are drilled according to the dimensions shown in Fig. 3 + 3.1.
2. Insert one of the wood screws into the top center hole. The control unit is hooked onto this screw. Therefore, leave the screw out by approx. 3 mm (Fig. 3.2).
3. Hook the control unit onto the 3 mm protruding screw in the upper mounting hole. Insert the supplied rubber grommets into the openings at the rear wall of the housing and insert the connecting cable through these openings.

Fasten the housing bottom at the two bottom openings (Fig. 4) firmly to the cabin wall.

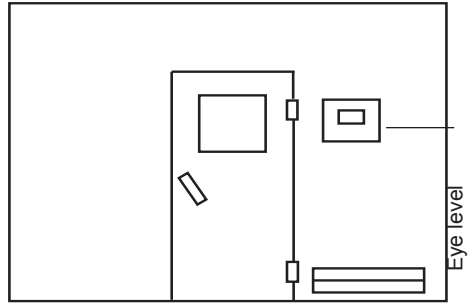

Fig. 3

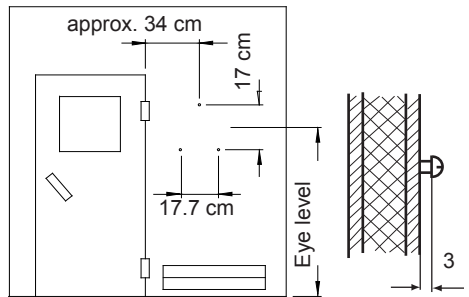

Fig. 3.1

Fig. 3.2

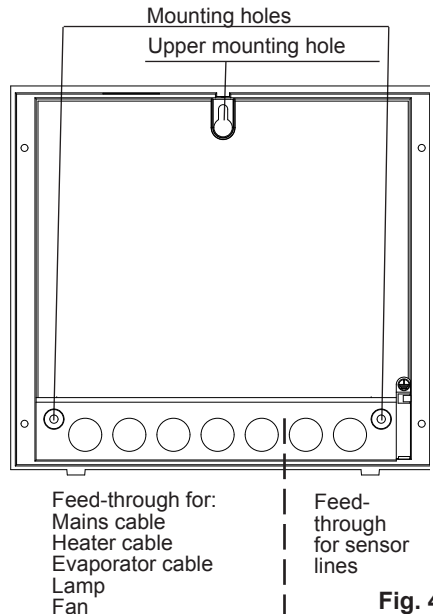
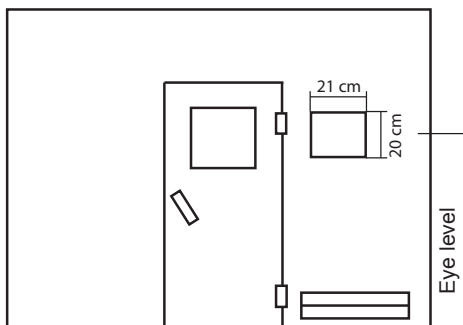

Fig. 4

## Wall recessing

1. Cut out a wall section that is at least 3.5 cm deep according to the dimension in Fig. 5.



**Fig. 5**

Insert the supplied rubber grommets into the openings at the rear wall of the housing and insert the connecting cables through these openings.

Place the control unit into the wall opening and fasten it with 4 wood screws.

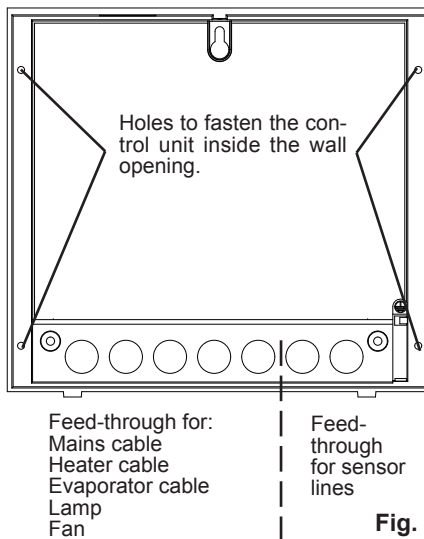

**Fig. 6**



## Connecting the sensor cables

You should not install sensor and power supply lines together, or lead them through the same feedthrough. This can lead to interferences in the electronics, such as "fluttering" in the relays. If it is necessary to lay the cables down together, or if the line is longer than 3m, use a shielded sensor cable (4 x 0.5 mm<sup>2</sup>).

Connect the shielding to ground in the control unit.

Please observe that the following dimensions relate to the values stipulated during the unit inspection acc. EN 60335-2-53. The heater sensor must always be installed at the point where the highest temperatures are to be expected. Illust. 7-9 give you an overview of the mounting point of the sensor.

2. Drill a hole to lead the cable through, preferably through the middle of one of the wooden boards.
3. Lead the sensor cable through the drilled hole and attach it to the sensor line according to Illust. 10.
4. The cables for the limiter (white) and the temperature sensor (red) are connected to the sensor circuit board acc. Fig. 10. Engage the sensor board into the casing.
5. Lead the sensor cables through the right cable intake into the control unit. Install the sensor cables inside the control unit as shown in Fig. 11. Connect the sensor cables as shown in Fig. 12. In order to do this, pull the plug **X2** from the circuit board and plug it back in after the connection.



## Installation of the heater sensor

1. Mount the oven sensor in cabins up to 2 x 2m according to Illust. 7 and 8, in larger cabins according to Illust. 7 and 9.

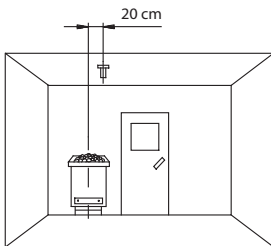

Fig. 7

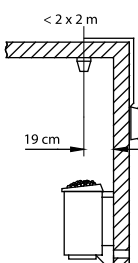

Fig. 8

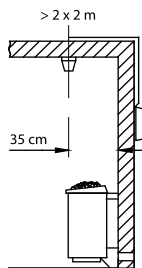
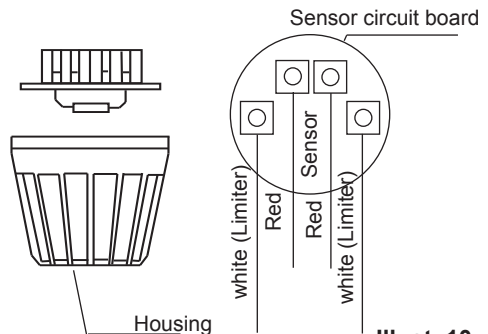

Fig. 9



Illust. 10

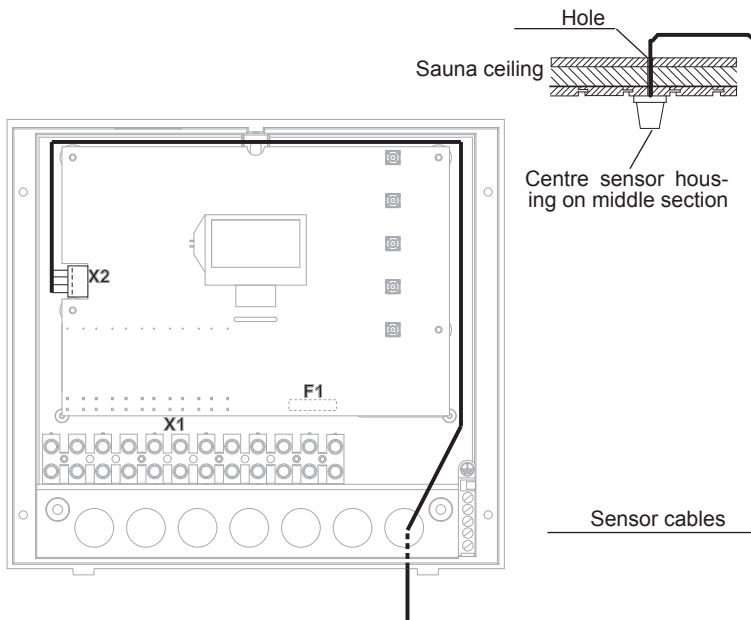

Fig. 11

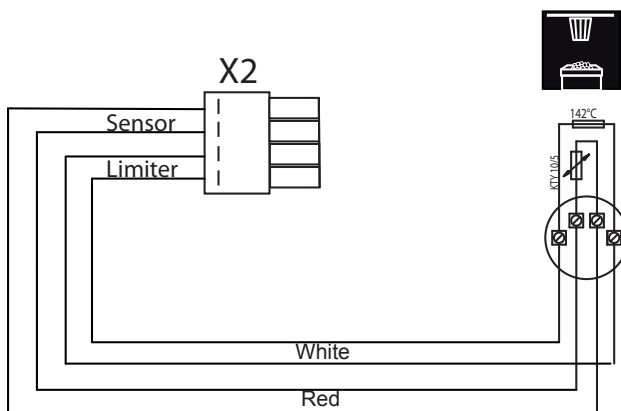
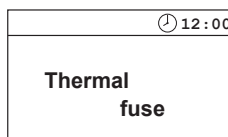

Fig. 12

6. After completed installation and correct operation of the control unit, the line for overtemperature protection must be checked for short-circuits. In order to do this, disconnect one of the white cables in the sensor casing. The respective error message appears in the display.



## Electrical connection

The electrical connection may only be done by a certified electrician in compliance with the guidelines of the local utility company and the VDE.

In general, there may be only one fixed connection to the network; therefore equipment should be provided that makes it possible to disconnect the system with all poles from the network with a contact opening width of minimum 3 mm.

All electrical installations and all connection lines that are installed inside the cabin must be suitable for an ambient temperature of at least 170 °C.

The power supply line is run to the control unit and connected to the power input terminals.



### Connecting the sauna heater

Install the sauna heater and the vaporizer in front of the air intake according to the manufacturer's installation instructions.

Run the silicone line through the ductwork to the power unit and connect it to the appropriate terminals as directed in the wiring diagram.

**Note:** In case there is no ductwork available drill a hole next to the air intake opening and run the heater line through this hole to the outside and to the appropriate terminals in the control unit. The silicone line must be buried to protect it from outside influences. Therefore, use a suitable cable-duct or a PVC-pipe through which you can run the line up to the power unit.



### Connecting the vaporizer

To connect the vaporizer, use silicone connecting lines 4 x 1.5 mm<sup>2</sup> as well.



**Warning:** When connecting vaporizer make sure it is correctly attached to the water bath (WB) and low water shutoff (WM). If you switch these connections, you disable the water deficiency function and bypass the thermostat. As a result, the vaporizer will overheat.

**Risk of fire!**

The control unit can detect water deficit if there is a zero-potential feed at the WM-input.



### Connecting the sauna lamp

The sauna lamp must be weatherproof protected (IPx4) and resistant to the ambient temperature. The sauna lamp may be installed at any location but never in the vicinity of the rising hot air of the heater.



### Connecting a fan

The fan must be weatherproof protected (IPx4) and resistant to the ambient temperature.

The fan can be mounted at any point, but never near to rising hot air from the heater and as far as possible from the installation position of the IR lamp (may not be in the direct beam).

# Installation diagram

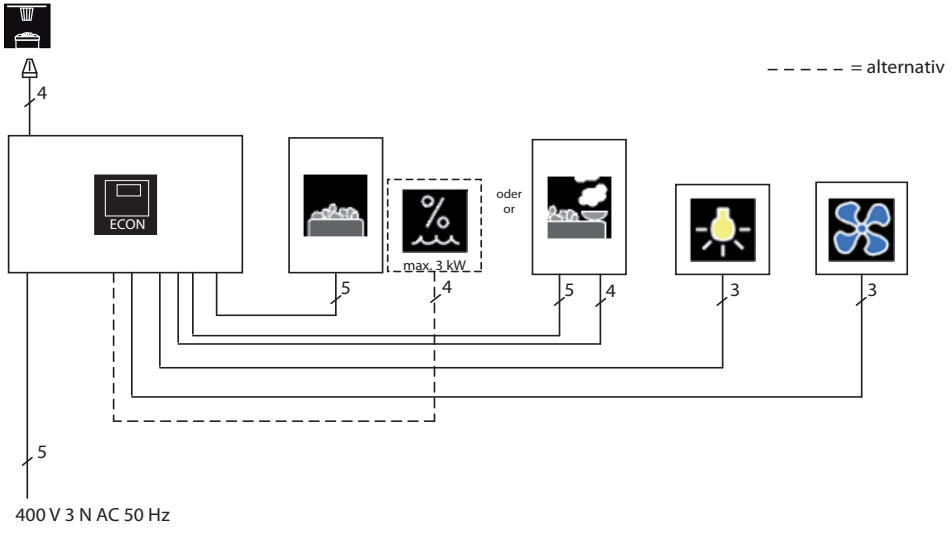

## Terminal arrangement on the circuit board.

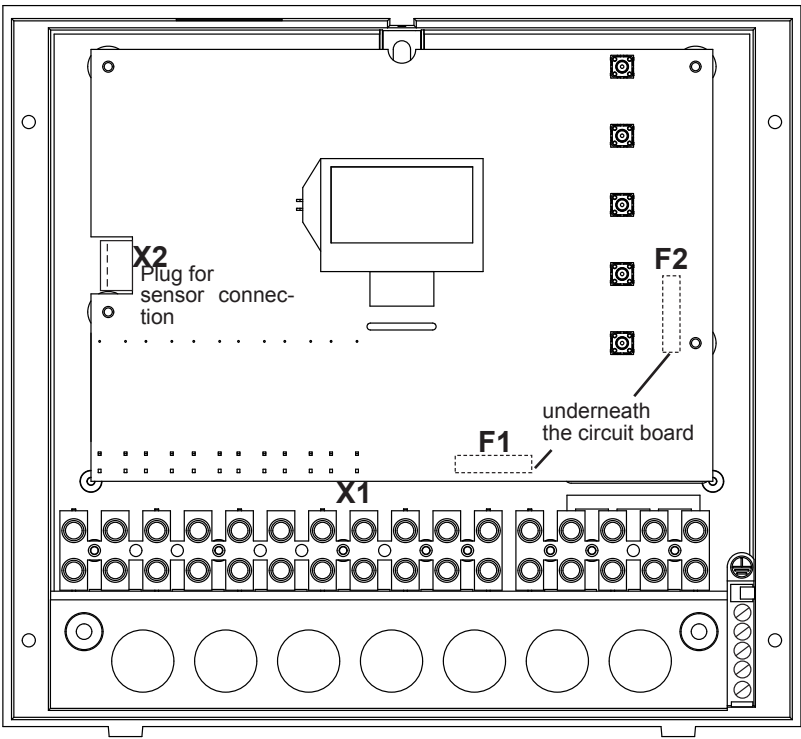

## Connecting the sauna heater (max. 9 kW)

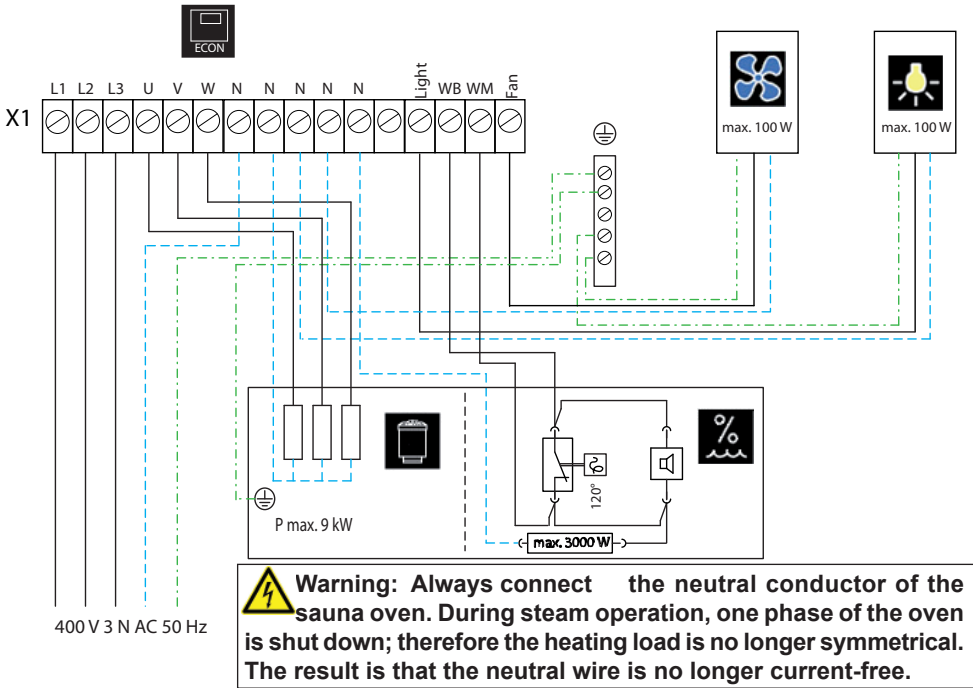

## Connection of vaporizer

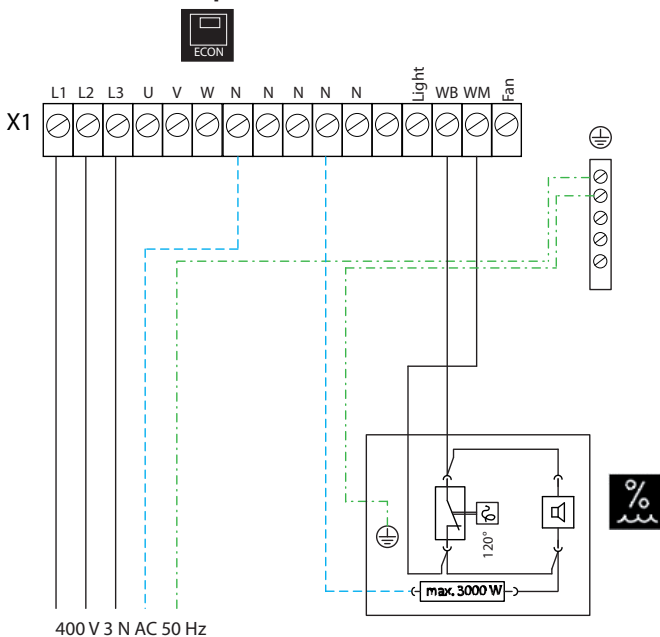

## Operation

Once the system has been installed with all components and all covers have been fixed, you can put your sauna unit into operation.

Over the following pages we will show you the options provided to you with the control.

## General

### The user interface

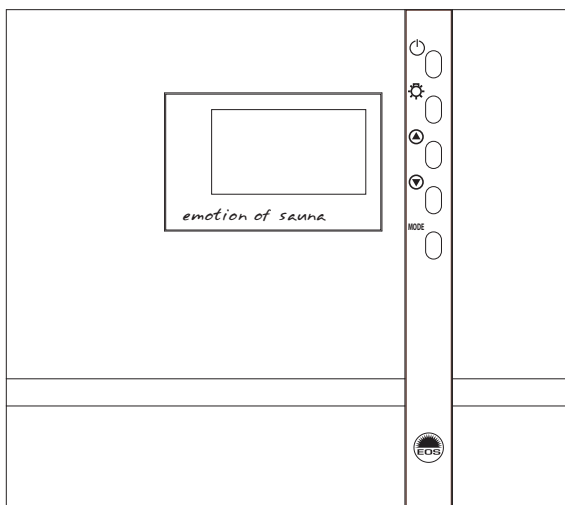

### Operating buttons

 = System On - Off

 = Cabin lighting

**MODE** = Programming mode

 = Increase the value

 = Decrease the value

## Default display Stand-by

is shown if the system is in Stand-by mode.

Reset to this display takes place from other menu items if no activity is carried out > 15 s.

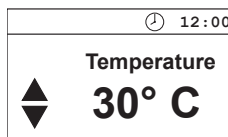

## Default display in operation

is shown if the system is in operation. The display switches between the set temperature and the remaining heating time (Auto-Stop).

Reset to this display takes place from other menu items if no activity is carried out > 15 s.

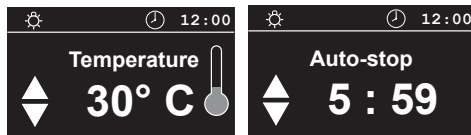

During the heating phase the thermometer fills up on the right side of the display.

## Energy-saving display

If the unit is not used, it will switch into energy-saving mode.

A moving time is shown after 5 minutes, similar to a PC screensaver. The back light for the display is switched off after an additional 15 minutes.



By pressing any key you can return to the Stand-by default display

The following applies for all settings:

The following is shown in the top area of the display:



The light - symbol  
(when the light is switched on)



The clock symbol

12 : 00

Current time

In addition, the following symbols are displayed depending on the operating mode selected.



Reheating phase  
(after the humidity operation)



Child lock active

Parameters that are highlighted in black on the display can be adjusted.

Parameters that blink on the display can be changed and are shown in these instructions as displayed.

In order to adjust the individual values to the particular desires, briefly push the ▲ or ▼ - buttons to select the desired parameter.

By briefly pushing the **MODE** -button again you will arrive at the programming level.

The name of the parameter is highlighted in black and the modifiable value is now blinking.

The blinking value can then be changed with the ▲ or ▼ - buttons.

All settings out of Stand-by are confirmed by pressing **MODE** > 3 s and are saved in the unit.

The blinking of the parameter ends and the new value is now authoritative until another change is made.

If no key is pressed for > 15 s., the unit switches back into the default display. Changes made up to then are not saved

## Cabin lighting

The cabin lighting is automatically switched on as soon as the sauna unit is switched on. In the top left of the display the ☀ - symbol is shown. When the sauna unit is switched off the cabin lighting will switch off with a delay of 30 minutes.

Irrespective of the status of the sauna unit, the cabin lighting can be ☀ switched on or off anytime with the button.

## Temperature

» 30° C «

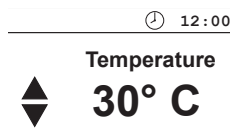

Modifiable parameter

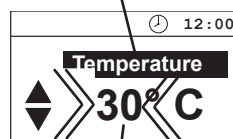

Modifiable value

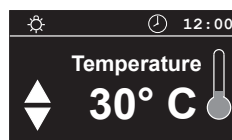
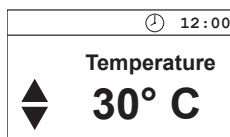



# Initial commissioning



MODE > 3 s

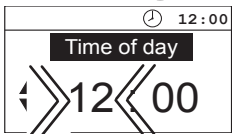
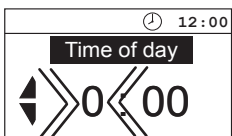

MODE

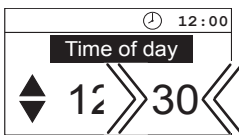
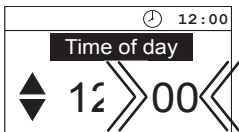

MODE > 3 s

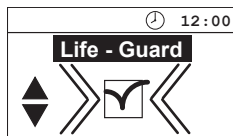
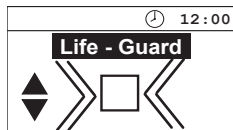

MODE > 3 s

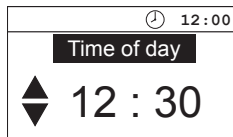

## Change language

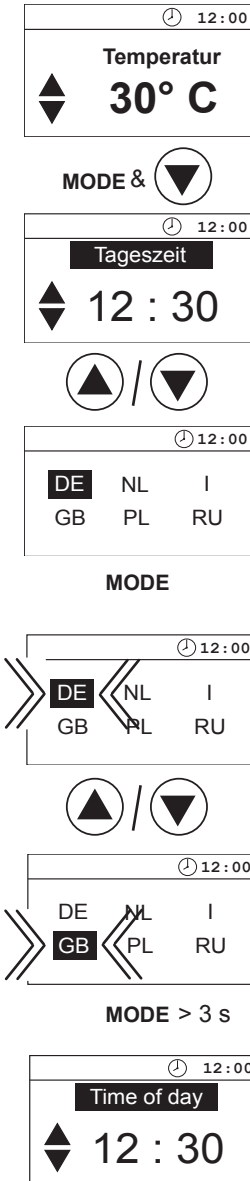

## Change time

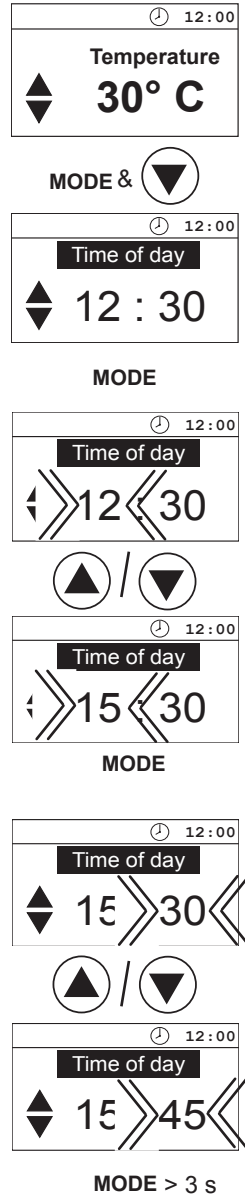

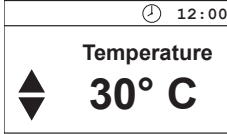
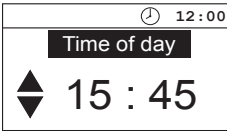

## Activating the Life - Guard

Life - Guard is a settable relatively short time, e.g. 20 minutes after which the sauna unit is switched off, except for the cabin lighting. After this time has elapsed the unit can be **MODE** switched on again by pushing the - button for the set time.

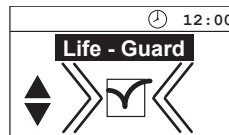
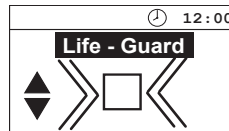
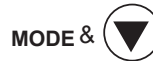
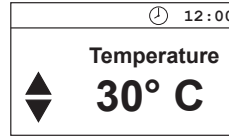

**MODE** > 3 s

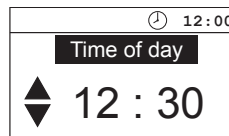

## Activate / deactivate the child lock

If the child lock is activated (the key symbol is visible in the top area of the display) only the cabin lighting can be switched. All other buttons are without function. Activating / deactivating the child lock can be done in Stand-by as well as in operation. The system can still be switched off in operation.

### Activate

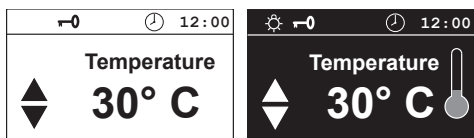
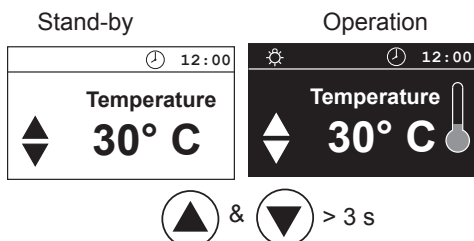

### Deactivate

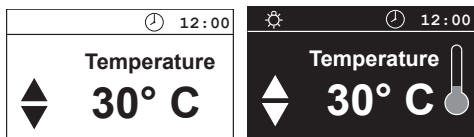
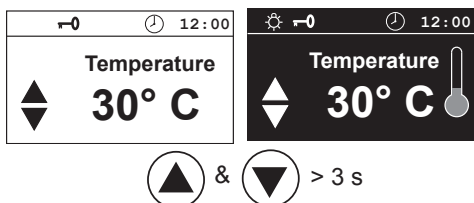

## Switching on the sauna unit

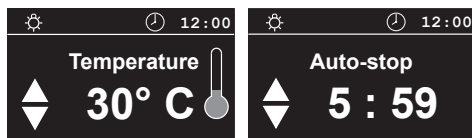
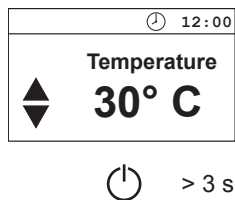

## Switching off the sauna unit in the Finnish mode

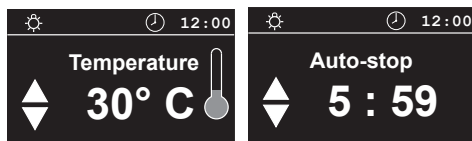

Auto-Stop-Time / ⏻

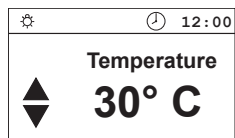

## Switching on the sauna unit with Life - Guard

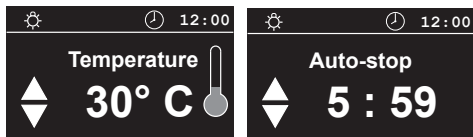
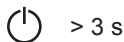
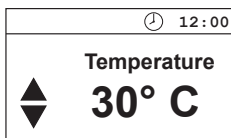

The sauna heater is now heating normally, without "Life - Guard"-time. To activate the function "Life - Guard".

### MODE

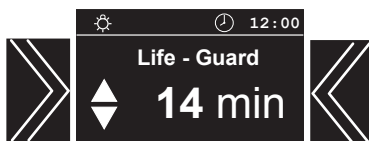

After expiration of the "Life - Guard" - time the sauna heater is switched off and the set "Life - Guard" - time blinks.



Restart

### MODE



or switch off the system

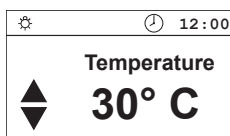

## Individual settings

Hereafter we are showing you options that allow you to adjust the controls to your individual needs. The various parameters can be changed in Stand-by or in operation and the changes are saved in the unit. Changes made in operation are effective directly.

**Cabin temperature** Setting range: Finnish mode 30 - 115°C  
Humidity mode 30 - 70°C

### In Stand-by

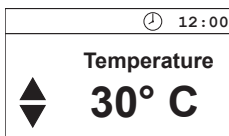

MODE

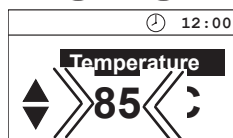
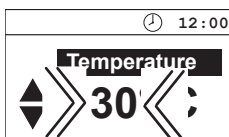

MODE > 3 s

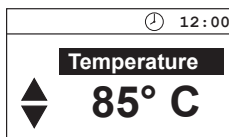

### In operation



MODE

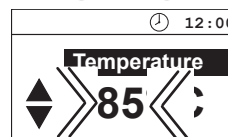
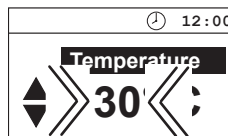

MODE > 3 s

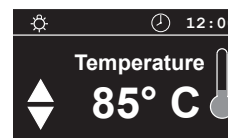



## Humidity operation

The prerequisite for humidity operation is the connection of a suitable evaporator unit up to max. 3 kW to 230 V AC. The control "clocks" the evaporator, dependent on the set nominal humidity value.

**Note:** Whilst the evaporator is being switched on, the heater only works with two phases, meaning that one of the switching phases is switched to the evaporator. On symmetrically wired heaters (same heating power per phase) one third of the heating power of the sauna heater is therefore switched off. This is done to protect the user from too high temperatures on the one hand, but also to limit the switching power to 3 kW per phase.

The humidity to be achieved is strongly dependent on the geometry of the sauna cabin, the sauna heater used and the evaporator power. Therefore, you will have to find your own personal climatic zone. Always select the temperature first (from 30 to 70°C) and then the humidity.

Heaters and evaporators which are optimally adapted to the sauna cabins can be used to achieve the humidity values given in the table with a 100% duty cycle.

Temperature	rel. air humidity
60°C	50 %
50°C	60 %
40°C	70 %
30°C	80 %

These achievable values lie higher than the values which are actually required. Therefore, after heating up, please lower them. Please observe that the cabin temperature is highest directly under the cabin ceiling, whereas the relative air humidity is low. The relative air humidity increases as the tem-

perature sinks towards the cabin floor.

The following diagram shows you the relative air humidity temperature values for the standard bath forms and comfort zones.

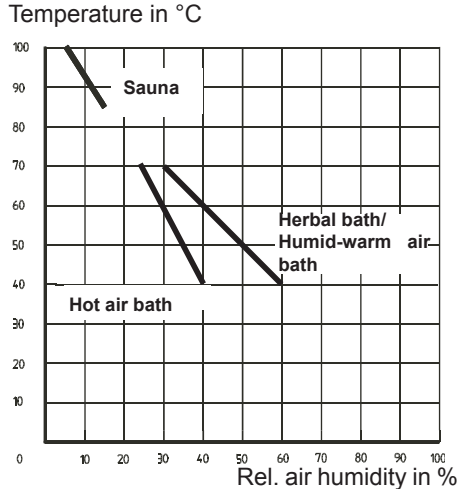

The humidity intensity shown in the display corresponds to the time proportional evaporator setting. Therefore, the relative air humidity is not preselected or shown on the display, but rather the switch-on frequency of the evaporator in percent. The graphic is intended to clarify this.

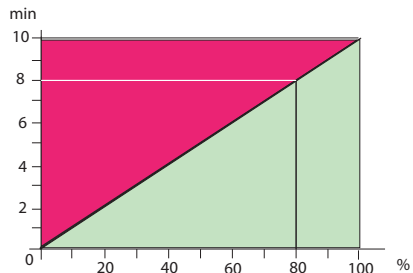

The evaporator is always activated if a value is displayed in the field „Humidity“. Please also observe that the evaporator does not switch on until the temperature has dropped to this value.

**Humidity intensity** If a value is entered here the sauna unit automatically goes into humidity operation when switched on.

### In Stand-by

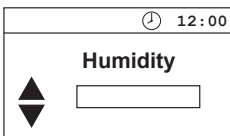
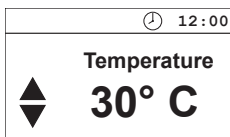

MODE

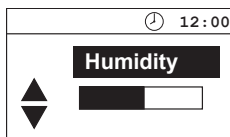
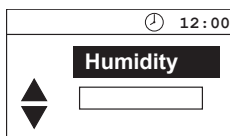

MODE > 3 s

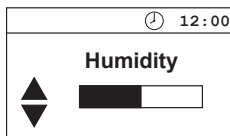

15 s /  > 3 s

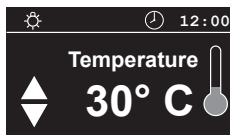
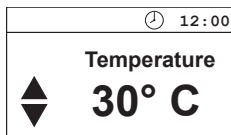

### In operation

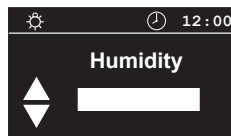
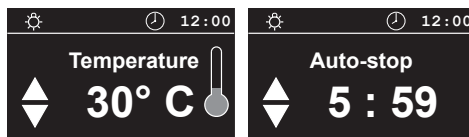

MODE

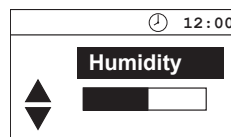

MODE > 3 s

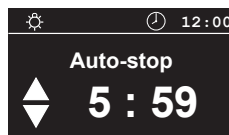





## Switching off the sauna unit during humidity operation

In order to dry out the sauna cabin after the humidity operation, a reheating phase is activated after the humidity operation is switched off. The cabin is heated here to 90°C for approx. 30 minutes. This is indicated by the blinking symbol in the top section of the display.  In addition, an optionally installed fan is switched on for the duration of the reheating phase.

The sauna unit automatically turns off once this time has expired.

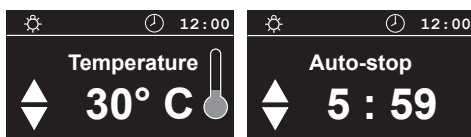
If you wish to interrupt the reheating phase beforehand, push the  -button again.



Auto-Stop. / 

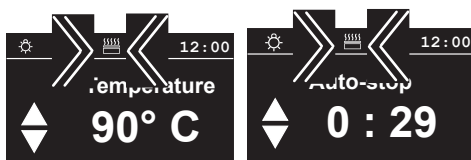

Auto-Stop. / 

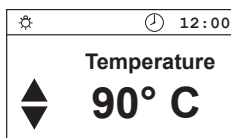

## Auto-Stop

Auto-Stop is the time to which the heating time is limited. The sauna unit automatically turns off once this time has expired.

The time is adjustable from 0:01 to 6:00 hours.

## In Stand-by

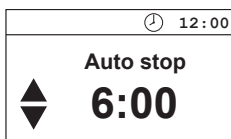
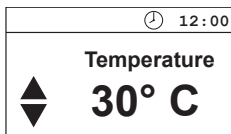

MODE

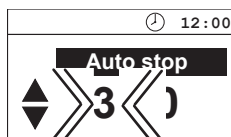
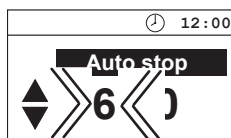

MODE

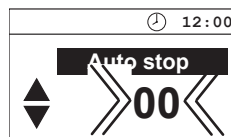

## In operation

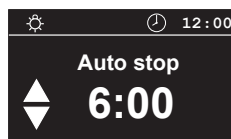
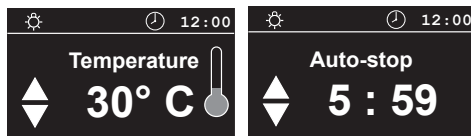

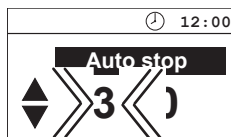
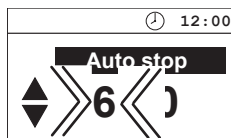

MODE

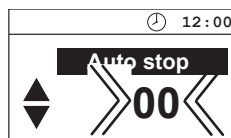

MODE

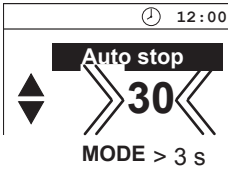



15 s /  > 3 s

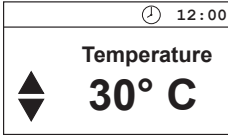
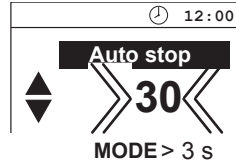

## Life - Guard

Here you can set after what time the sauna unit is switched off and by pushing the **MODE** - button again you can restart the „Life - Guard“ time.

This setting can only be selected in Stand-by when the function „**Life - Guard**“ is activated.

### In Stand-by

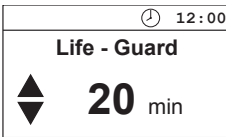
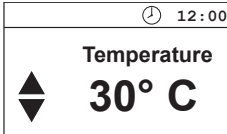

**MODE**



**MODE**

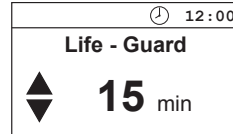

15 s /  > 3 s

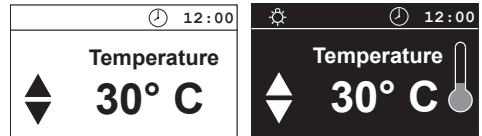

## Unit fuses

You will also find 2 micro fuses on the backside of the circuit board

F1 = T 2A Fuse primary electronics and light and fan

F2 = T 250 mA Fuse secondary electronics

**Caution!** Such work must be left exclusively to an expert. Prior to any kind of work disconnect all poles on the opened control unit from the power supply.

Open the unit as described in the Chapter Installation.

Loosen the four screws on the opened unit that hold the circuit board.

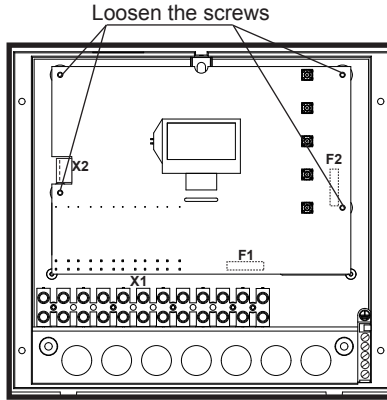

You will find the two fuses on the backside of the circuit board

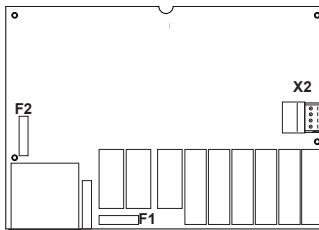

## Error messages

The control unit continuously monitors the sensor for short circuits and interruptions. At the same time it checks if there is enough water in the evaporator container.

The error messages appear as follows:

### Display

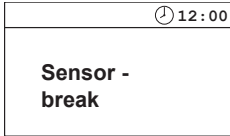

### Cause

= Interruption in the room sensor circuit  
The temperature sensor (KTY) is defective or the line to the temperature sensor is interrupted.

### Remedy

Have cables and KTY checked by an expert.  
KTY at 20°C approx. 2 kΩ may have to be replaced.

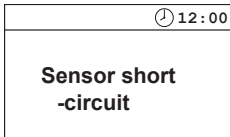

= Short-circuit in the room sensor circuit  
The temperature sensor (KTY) is defective, or the line to the temperature sensor is short-circuited.

Have cables and KTY checked by an expert.

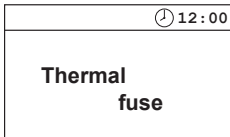

= Interruption in the limiter circuit  
The thermal fuse (142°C) has tripped or the line to the thermal fuse is interrupted.

Have cables and thermal fuses checked by an expert.



= Water shortage  
The water in the evaporator container is used up.

Refill water.

 **Warning.** There are hot components inside the container. There may be strong steam generation when refilling with cold water. **Danger of scalding!**

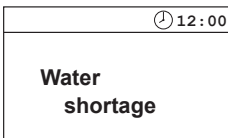

If no water is refilled the system switches off after 2 minutes.

In order to put the system back into operation, it must first be  switched off with the - button, then refill the evaporator container, and then the unit can be switched on again as usual.

## The device switch (Switch-off)

The unit switch is located at the top of the control unit. You can disconnect the electronics from the mains using this switch in case of a fault.

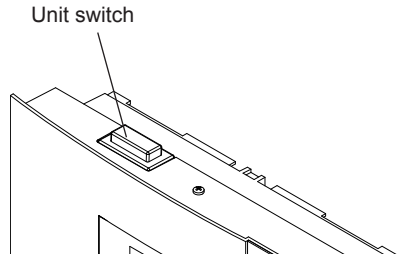

**Unit switch**

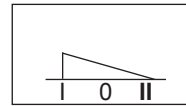

= Unit switched on

In case of faults push the unit switch on the left side of the rocker to the first latch (switch setting 0). The unit is now completely switched off.

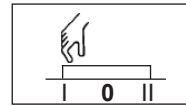

= Unit switched off

To turn the light on in the cabin when the unit is disconnected, push the left part of the rocker to the second engagement point (switch setting II).

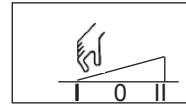

= Lamp switched on

To make the unit ready for operation, switch back to the initial position (switch setting I).

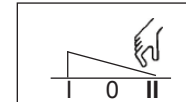

Please keep this address in a safe place together with the installation guide.

To help us answer your questions quickly and competently, please provide data printed on the ID plate, to include system type, article no. and serial no., in all inquiries.

### **Service Address:**

EOS-WERKE GÜNTHER GmbH  
Adolf-Weiß-Straße 43  
35759 Driedorf-Mademühlen, Germany  
Fon: +49 (0)2775 82-514  
Fax: +49 (0)2775 82-431  
servicecenter@eos-werke.de  
www.eos-werke.de

## **Guarantee**

The guarantee is taken over according to the legal regulations at present.

### Manufacturer's warranty

- The period of warranty starts from the date of purchase and lasts up to 2 years for commercial use and 3 years for private use.

- Always include the completed warranty certificate when returning equipment.

- The warranty expires for appliances which have been modified without manufacturer's explicit agreement.

- Damages caused by incorrect operation or handling through non-authorized persons are not covered under the terms of warranty.

- In the event of a claim, please indicate the serial number as well as the article code number and type name with expressive description of the fault.

- This warranty covers damaged parts but no defects due to wear and tear.

In case of complaint please return the equipment in its original packaging or other suitable packaging (caution: danger of transport damage) to our service department.

Always include the completed warranty certificate when returning equipment.

Possible shipping costs arising from the transport to and from point of repair cannot be borne by us.

Outside of Germany please contact your specialist dealer in case of warranty claims. Direct warranty processing with our service department is in this case not possible.

Equipment start-up date:

Stamp and signature of the authorized electrician:



## Handling procedures for return shipments (RMA) - Details for all returns !

Dear customer

we hope that you will rejoice in the ordered articles. Just in case that you are not entirely contented as an exception, please follow the procedures specified below. This enabling us to ensure a quick and smooth handling of the return shipment.

### Please absolutely respect for all returns!

- Please add the available **RMA-voucher** always **completely filled out** together with an **invoice copy** to the return shipment! Do not stick it on the goods or on the packaging. **We do not accept the return shipment without these papers.**
- Not prepaid parcels **will be refused** and returned to Sender! Please always ask for the **RMA-No.** for the cheapest return.
- **Please pay attention that** the goods have to be sent back **without visible marks of use** in the **original scope of delivery and in original packing.**
- We recommend to use an **additional solid and break-proof covering box** which should be padded out with styrofoam, paper or similar. Transport damages as a result of faulty packing are for the sender's account.

### Form of complaint:

#### 1) Transport damage

- Please check the content of your parcel immediately and advise the forwarding company of a claim (parcel service/ freight forwarder)
- Do not use damaged goods!
- Ask the forwarder **for a written acknowledgement of the damages.**
- **Report the claim promptly by phone to your dealer.** He will discuss with you how to act in this case.
- If the transport box has been damaged, please use an additional covering box. Do not forget to add the **acknowledgement of the damage of the forwarding company !**

#### 2) Faulty goods

- The implied warranty period is 2 years. Please contact your dealer in case of **faulty or wrong articles or missing accessories.** He will discuss with you the individual case and try for immediate and customer-friendly solution.
- For **economic returns** within Germany you will get an **RMA-number from the manufacturer.**
- All returns have to be in the **original packing of the goods with corresponding accessories.** Please repack the goods to avoid damages. In case of wrong delivery, please do not use this article !

#### 3) Problems of installation and functioning

- Please **read the manual carefully first of all** and pay attention to the indicated assembly or installing instructions.
- **Your dealer should be the first contact person** because he knows his products best and also knows possible problems.
- **In case of function problems with an article,** please check at first whether there is an obvious material defect. The quality system in our factory reduces malfunctions of new appliances to almost zero.