

Steamtec AIO

Steam Generator Manual



**DO NOT use locking pliers to over tight the
DRAIN PIPE connection**

Please read the manual carefully before installation
and keep the manual for further reference

Table of Contents

1. Configuration List.....	3
2. Introduction.....	4
3. Safety Warning.....	5
4. Install Cautions.....	5
5. Parameters.....	6
5.1. Models, parameters and dimension.....	6
5.2. Steam generator construction.....	7
5.3. Controller parameters and dimension.....	8
6. Installation And Cautions.....	9
6.1. Installation cautions.....	9
6.2. Installation of steam generator body.....	9
6.2.1. Cautions.....	9
6.2.2. Installation.....	9
6.3. Installation of Central function box.....	10
6.4. Installation of controller and temperature sensor.....	12
6.5. Installation of pipeline.....	16
6.6. Installation of electrical circuit.....	18
6.6.1. Power Supply.....	19
6.6.2. Wire Diagram.....	19
7. Functions And Operation.....	25
7.1. Control panel display items.....	25
7.2. Auto Functions.....	30
8. Maintenance.....	31
9. Troubleshooting.....	32
10. Warranty And Services.....	34
11. Appendix: Parameter Of Special Models.....	35
MAINTENANCE RECORD(Regular descaling records).....	36

1. Configuration List

When receive the steam generator, please check if you have get complete set according to below chart or not, contact us immediately if any missing.











Photos	Item name	Quantity
	Steam generator in stainless steel housing	1pc
	Controller+housing box, waterproof touch screen	1set
	Central function box	1pc
	Central function box power cord	1pc
	3/4" Full-bore straight auto drain valve	1pc
	Control cable, length 5 m (central function box -> controller)	1pc
	Temp sensor with box, length 5 m (central function box -> sensor end position)	1pc
	Central function box cable (steam generator -> central function box)	1pc
	Stainless steel#304 steam nozzle	1pc for 3kw~13.5kw; 2pcs for 15kw~24kw
	Safety valve	1pc
	English User Manual	1pc

Table 1

2. Introduction

Thank you for choosing “Steamtec” AIO series steam generator with well-designed structure, steady performance and convenient installation. This steam generator can work with the steam room, to form a whole steam-bath system. The steam-bath is for removing tiredness, relaxing muscles and stimulating blood circulation.

For proper installation, operation, maintenance, and the safety of customer as well, please read all instructions carefully and keep this manual for further reference.

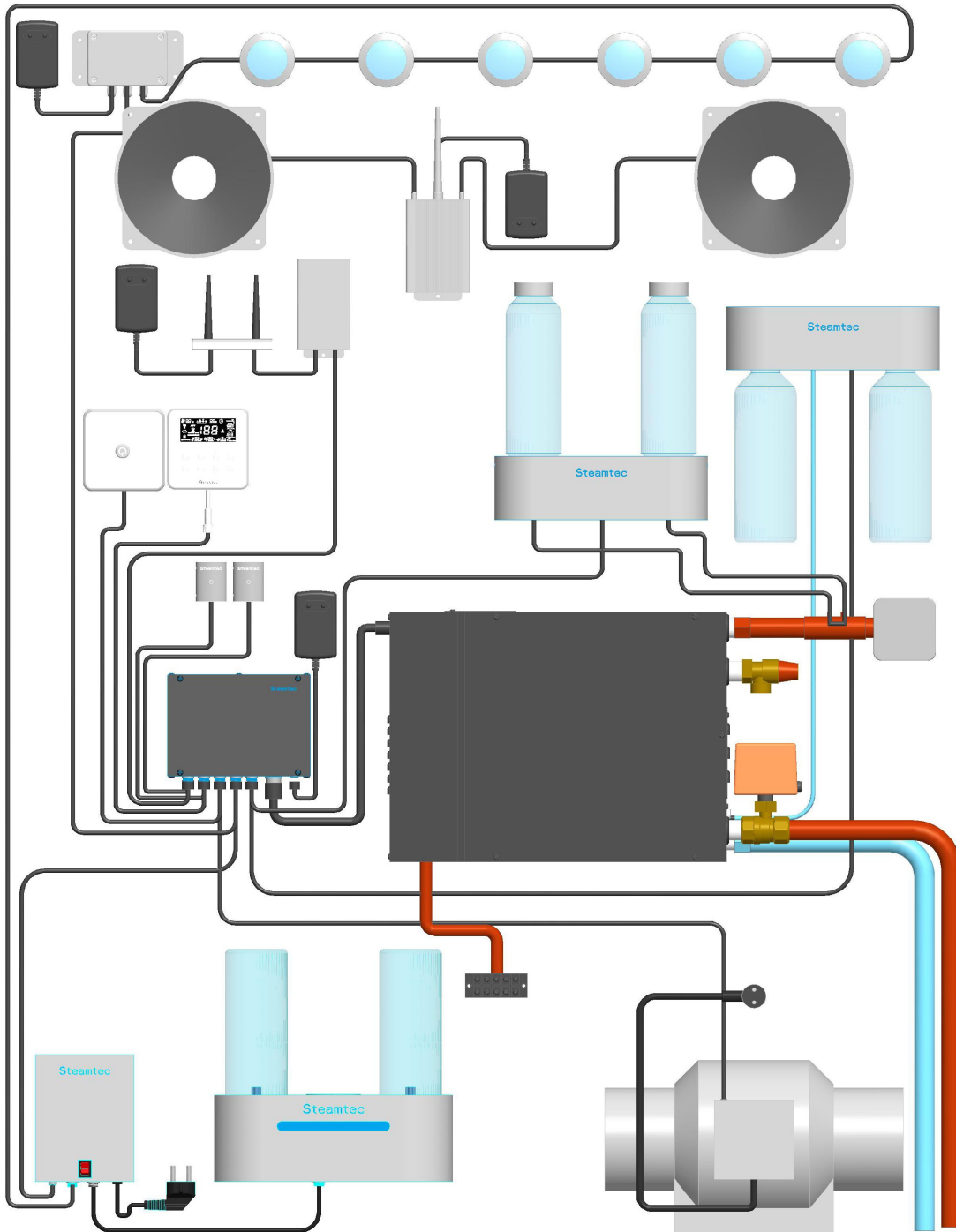

Figure 1 The whole AIO steam bath system

3. Safety Warning

- This appliance is not intended for use by person with reduced physical, sensory or mental capabilities, under 16 years old, or lack of experience and knowledge, unless they have been given supervision or instruction concerning use of the appliance by a person responsible for their safety.
- Children should be supervised to ensure that they do not play with the appliance.
- Check steam room before restart the controller.
- Smoking and alcohol are not allowed inside the steam room.
- Leave the steam room immediately when feels uncomfortable.
- A ventilation fan is required for the steam room.
- This steam generator is for heating up the steam room, please don't change its functions or usage by yourself, unless under the help or the guide of someone who can be responsible for the safety.



When you go out, or may not use the steam generator in long time, please DISCONNECT the steam generator general power supply and general water supply.

4. Install Cautions

- If the generator is installed at a place where difficult for customer access, the water supply valve must be easy to access for emergencies.
- GFCI must be installed on the power supply, and the power supply, power wire, fuse and breaker must comply with the nameplate on the unit and table 2 in this manual.
- The solenoid valve can endure maximum 0.8MPa (8kg/cm²) water pressure. To protect the solenoid valve from extremely high water pressure, please turn down the inlet slightly or install water pressure relieving valve.
- Do not install saddle-backed or needle valves on the inlet. Please dredge and clean the pipe before installation.
- No block valve should be installed in the steam pipelines. Strictly no blocked or blended pipe, otherwise have negative effect on the flow of steam and condensate. The steam pipelines should be installed with a slight angle so that the condensate can flow back to the generator or the steam head.
- Steam generator should be installed indoor to avoid frozen. The generator should be installed and leveled with the arrow pointing upward at an easy-access place, otherwise do not switch on.
- The steam pipeline must be copper pipes or stainless steel pipes, all other material such as plastic, acrylic should not be used since they cannot endure 150°C or higher temperature.
- All inlet and apertures should be sealed to prevent any leakage of steam and to protect the generator and customers.
- Don't drain water to the steam room from the water tank as may cause serious scald and damage the steam room.
- All inlet water pipes and steam pipelines should be built according to the National Standard and this should be done before sealing the wall.

5. Parameters

5.1. Models, parameters and dimension

(Only apply to European style voltage and phase)

Model	Power	Phase	Heating elements	Voltage / Current	Power wire	Breaker	Room volume	Dimension (L*W*H)
	kW	N	N*KW	V/A	N*mm2	A	m3	mm
TOLO-30	3.0	1	2*1.5	215-240/13.6	3*2.5	16	2~3	425*160*315
TOLO-40	4.0	1	2*2.0	215-240/18.2	3*2.5	25	3~5	
TOLO-45	4.5	1	3*1.5	215-240/20.5	3*2.5	25	3.5~5.5	
		3		380-415/6.8	5*1.5	16		
TOLO-50	5.0	1	2*1.5+1*2.0	215-240/22.7	3*2.5	32	4~6	
		3		380-415/9.1	5*1.5	16		
TOLO-60	6.0	1	3*2.0	215-240/27.3	3*4.0	40	5~7	
		3		380-415/9.1	5*1.5	16		
TOLO-70	7.0	1	2*2.5+1*2.0	215-240/31.8	3*6.0	40	5.5~8	
		3		380-415/10.6	5*2.5	16		
TOLO-75	7.5	1	3*2.5	215-240/33.75	3*6.0	60	6.5~9	
		3		380-415/11.25	5*2.5	16		
TOLO-90	9.0	3	6*1.5	380-415/13.6	5*2.5	16	8~11	475*185*450
TOLO-105	10.5	3	3*1.5+3*2.0	380-415/15.9	5*2.5	25	9~12	
TOLO-120	12.0	3	6*2.0	380-415/18.2	5*2.5	25	11~14	
TOLO-135	13.5	3	3*2.0+3*2.5	380-415/20.25	5*2.5	32	12~15	
TOLO-150	15.0	3	6*2.5	380-415/22.7	5*2.5	32	13~18	
TOLO-165	16.5	3	6*2.0+3*1.5	380-415/24.75	5*4.0	40	14~20	510*185*460
TOLO-180	18.0	3	9*2.0	380-415/27.3	5*4.0	40	16~22	
TOLO-225	22.5	3	9*2.5	380-415/34.1	5*6.0	60	19~26	
TOLO-240	24.0	3	6*2.5+3*3.0	380-415/36.4	5*6.0	60	22~30	

Table 2

Notice:

- The rated power is measured under single phase 230V, therefore the actual operating power under single phase 215-240V, 50/60Hz, or three phases 380-415V, 50/60Hz may be different from the rated value.
- 3KW and 4KW machine, can be only under 215-240V single phase. Please note the earth wire should not less than 1.5mm².
- From 4.5KW to 8KW machine, can be made as 215-240V single phase or 380-415V three phases. Please note the earth wire should not less than 1.5mm², the live wire and null wire should not less than 2.5mm².
- More than 9KW machine, can be only under 380-415V three phases. Please note the earth wire should not less than 2.5mm², the live wire and null wire should not less than 4.0mm².

How to choose the right KW steam generator?

Step One: Calculate the steam room m³, (Length*Width*Height) in meter.

(1 feet = 0.3048 meter, 1 inch=0.0254 meter)

Step Two: Check your steam room materials

- If Acrylic, steam generator KW= steam room m³
- If Ceramic Tile, steam generator KW= 1.30 X steam room m³
- If All Glass tile or Glass Block Walls, steam generator KW= 1.35 X steam room m³
- If Porcelain tile, steam generator KW= 1.6 X steam room m³
- If Natural stone tiles* up to 1/2", steam generator KW= 2 X steam room m³
- If Natural stone slabs over 1/2", steam generator KW= 2.25 X steam room m³

5.2. Steam generator construction

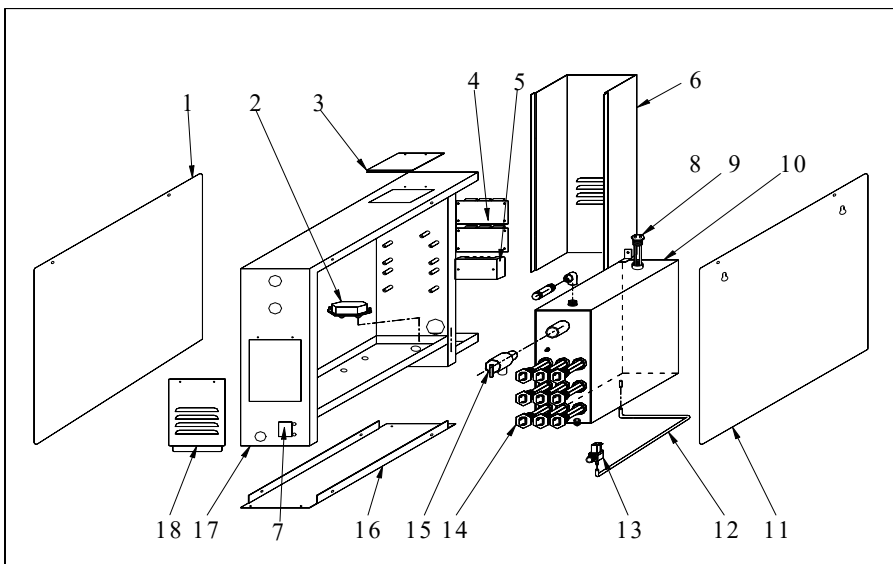

1. Front Cover
2. Wire entry hole
3. Small cover
4. Sub-board(relay board)
5. Wire terminal
6. U shape cover
7. Water inlet position
8. Steam outlet
9. Water level sensor
10. Inner tank
11. Black Cover
12. Water inlet hose
13. Solenoid water inlet valve
14. Heating elements
15. Safety valve

16. Base plate
17. Drain valve
18. Element access cover

Figure 2 Steam generator structure chart

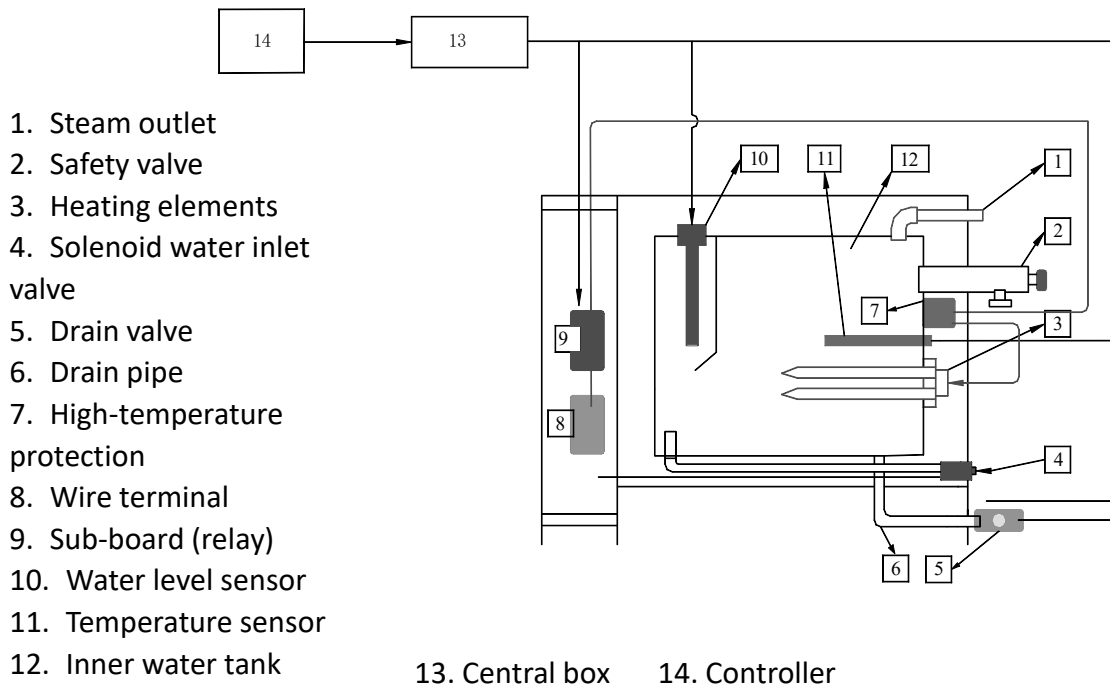

Figure 3 Steam generator schematic diagram

5.3. Controller parameters and dimension

Controller model	Controlling time range (minutes)	Temperature showing range	Temperature controlling range	Dimension (mm)
AIO	1~60 or long-term (CH)	6~60°C (43°F ~ 140°F)	35~60°C (95°F ~ 140°F)	103*103*45

Table 3

Notes:

AIO Controller can be installed inside the steam room.

However, we recommend you to install the controller outside the steam room to extend its service life.

Figure 4 AIO controller



6. Installation And Cautions

6.1. Installation cautions

- ◆ **DO NOT use locking pliers to over tight the DRAIN PIPE connection.**
- ◆ **Before installation, MUST read all the install Cautions in this manual, on page 5.**
- ◆ **Selecting the proper steam generator**

In order to achieve comfort and relaxation, as well as energy efficiency, the selection of the correct steam generator model and size are as critical as design of the steam room itself. The power supply and circuit protector should be carefully checked to match the parameters of the generator. Please referring to the table 2 & its notice and select the suitable model for your specification.

6.2. Installation of steam generator body

6.2.1. Cautions

- Switch off all power supply before installation, and check whether you have the correct model for your steam room according to table 2 & its notice.
- Do not install the generator outdoors, in wet/moist place, freezing, or corrosive place. Do not install the generator near to inflammables such as oil paint, diluents and fuel. Be alert to the steam pipeline and safety valve since the high temperature of steam is dangerous to customers.
- Generator must be level installed.
- The generator should be installed in a dry and well-ventilated place. It can be installed either on the wall or on the ground, but must be well fixed. Install the generator to steam room as close as possible, such as in the closet, under the washing basin or in the basement. (Refer to figure 5).

6.2.2. Installation

- i. Install the generator on the wall: drill two small holes with diameter of 8mm on the wall, insert the expansion screws and then hang the generator on those screws.
- ii. Install the generator on the ground or deck: install a frame on the site and then screw the generator into the frame.
- iii. Central function box should be installed near to the steam generator as near as possible, as the length of the cable (connecting the steam generator and the central function box) is 50cm. Please don't use other extended cable, only the cable we provided is allowed.
- iv. For better service and maintenance, please install the generator with the nameplate face to front and leave more than 250mm space around the generator.

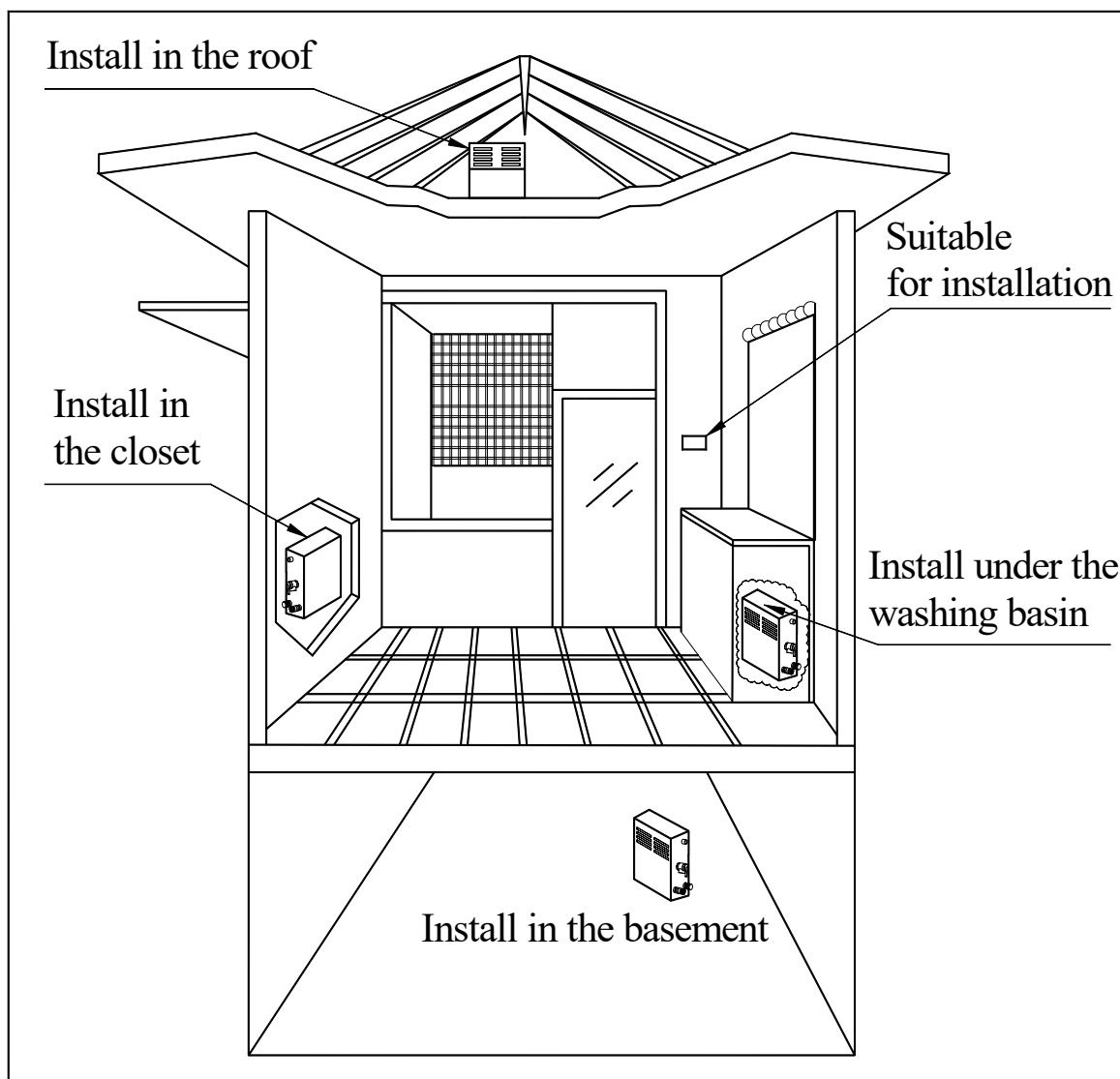

Figure 5 Places to install steam generator

6.3. Installation of Central function box

- Central function box should be installed near to the steam generator, as the cable for connecting the central function box and the steam generator is only 50 cm.
- Please hang the central function box on the wall.
- It need separate power supply, it's provided with plug.
- Connect the function equipment (Like aroma pump, color lights etc) to the central function box respectively.



Figure 6 Central function box

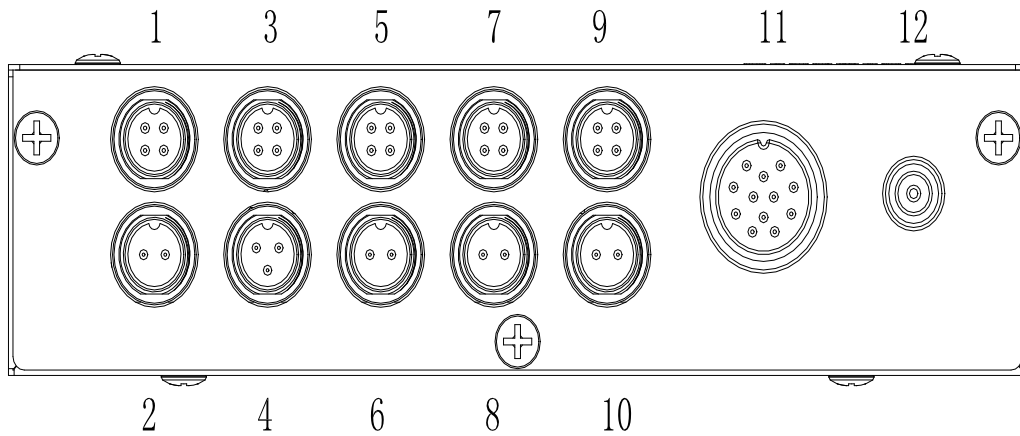

Figure 7 Central function box connectors

- | | |
|----------------------------------|--------------------------------------|
| 1. APP | 7. Color lights |
| 2. Steam room temperature sensor | 8. Salt spray generator |
| 3. Controller | 9. Aroma pump |
| 4. Steam room humidity sensor | 10. Descaling pump |
| 5. Fast steam switch | 11. Connector to the steam generator |
| 6. Fan | 12. Power supply 12V DC |

Connect the steam generator with the central function box by using the 12-core cable we provided. Please install the central function box near to the steam generator as close as possible. Please note the 12-core cable can't be extended, and only from original factory is allowable.

NOTES: (indicators explanation)

- D34: Main board power supply indicator
- D39: Relay contact on-off state indicator
- D24: Water level detection signal indicator
- D18,D19,D20: Heating indicator

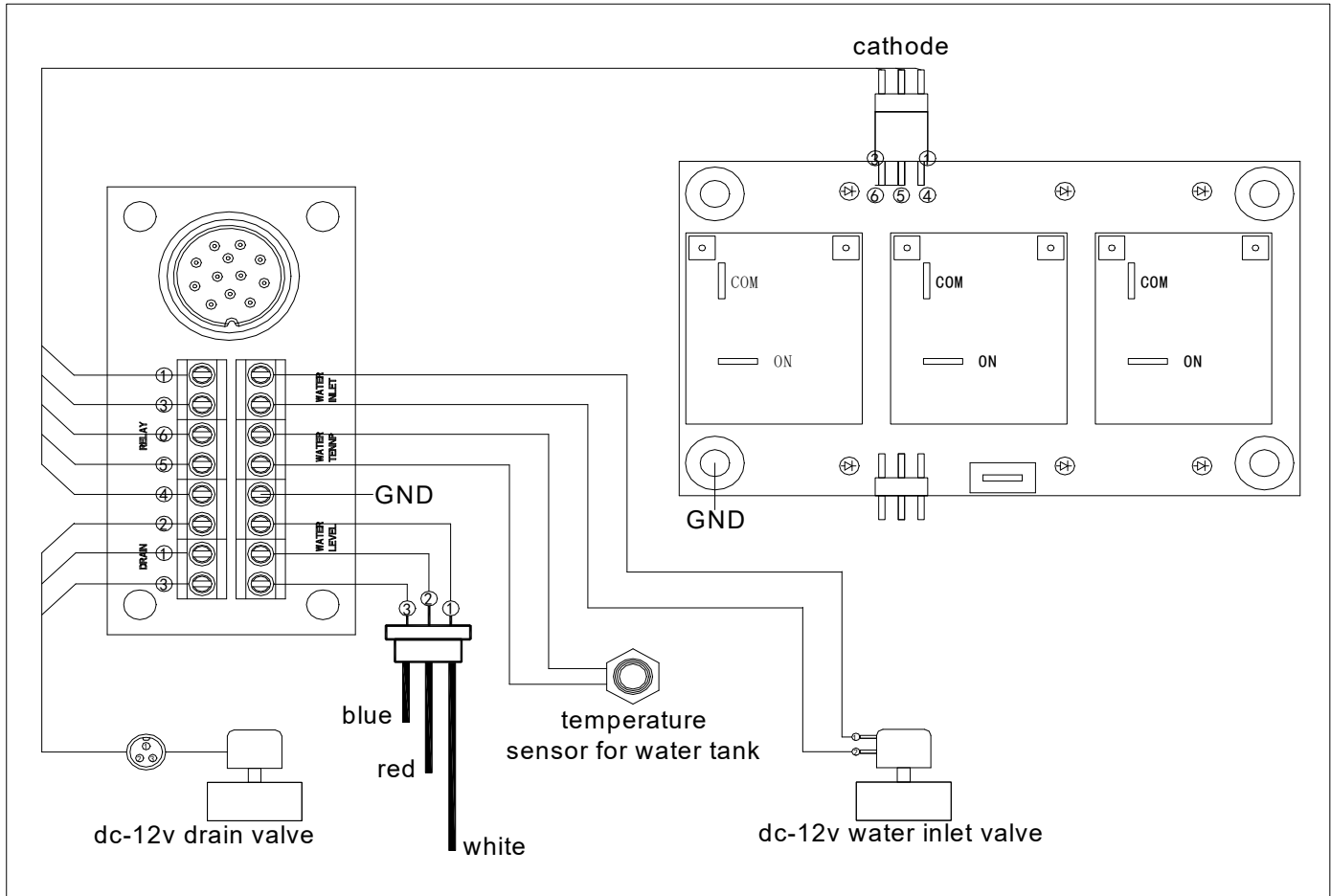

Figure 8 Steam generator 12-core cable socket corresponding functions

6.4. Installation of controller and temperature sensor

6.4.1. Cautions

The control wire and temperature wire should not be parallel to or intersect with the power wire. The temperature sensor should NOT be installed on the side of the wall which is behind the door.

6.4.2. Installation of controller

The controller should be installed with height of 1.2 m inside or outside the steam room but nearby or other place where easy to operate. Firstly follow below 4 steps for install housing box, then pull the control wire through the conduit, then connect the control wire to the central function box. Finally the controller can be insert to the housing box on the wall (Refer to figure 9).

Steps for install housing box:

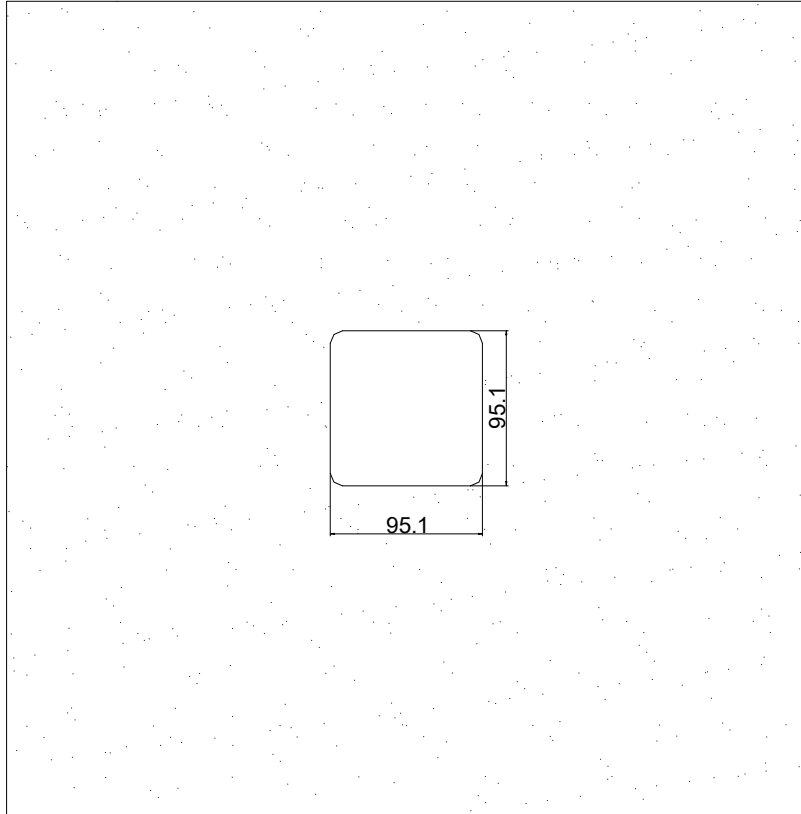

First step: open the hole on wall :95*95MM Depth:34MM

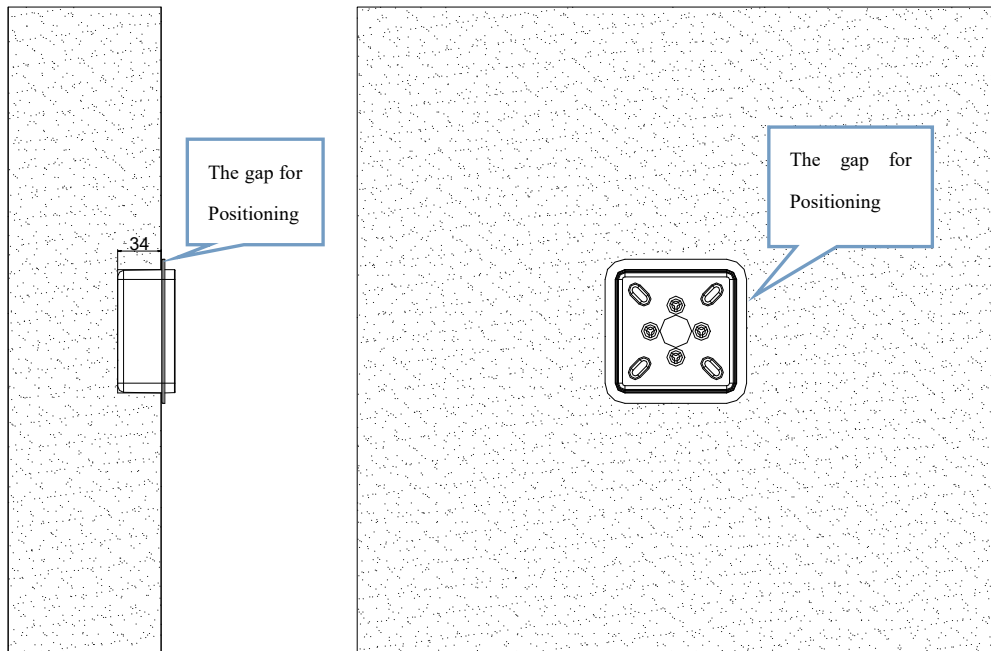

Second step: Housing box into the wall at the gap, horizontal installation

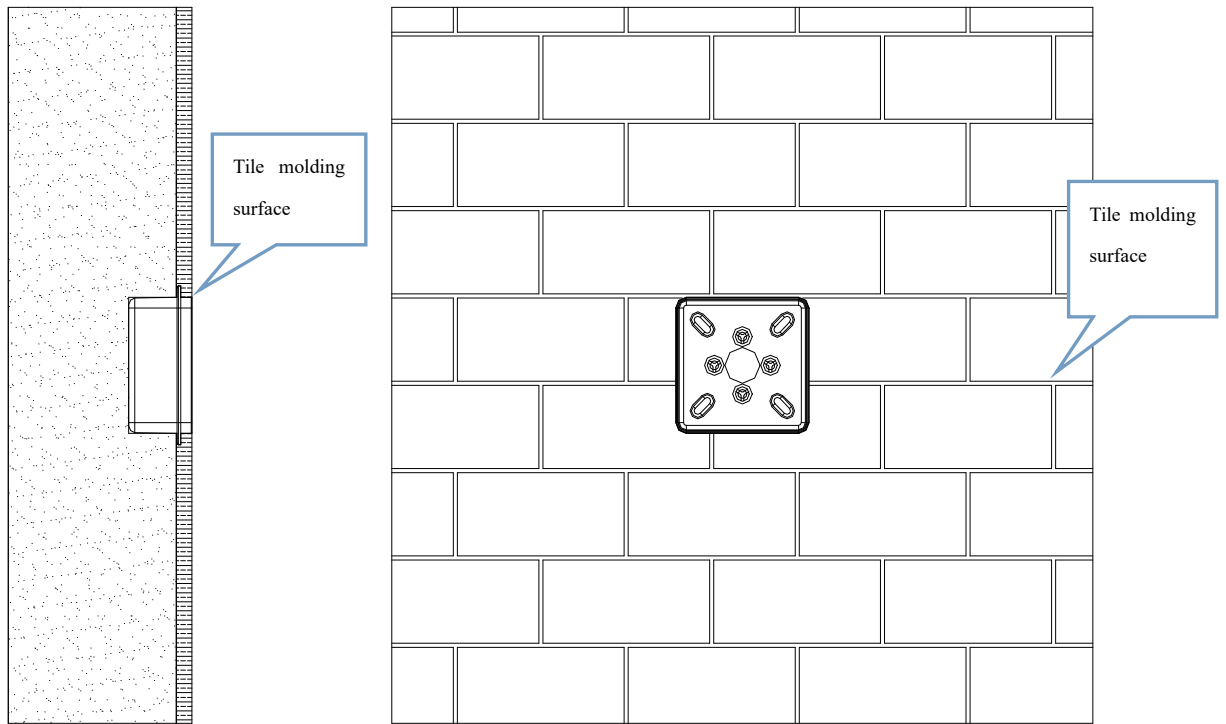

Third step: make the tiles cover the gap and keep in line with tiles

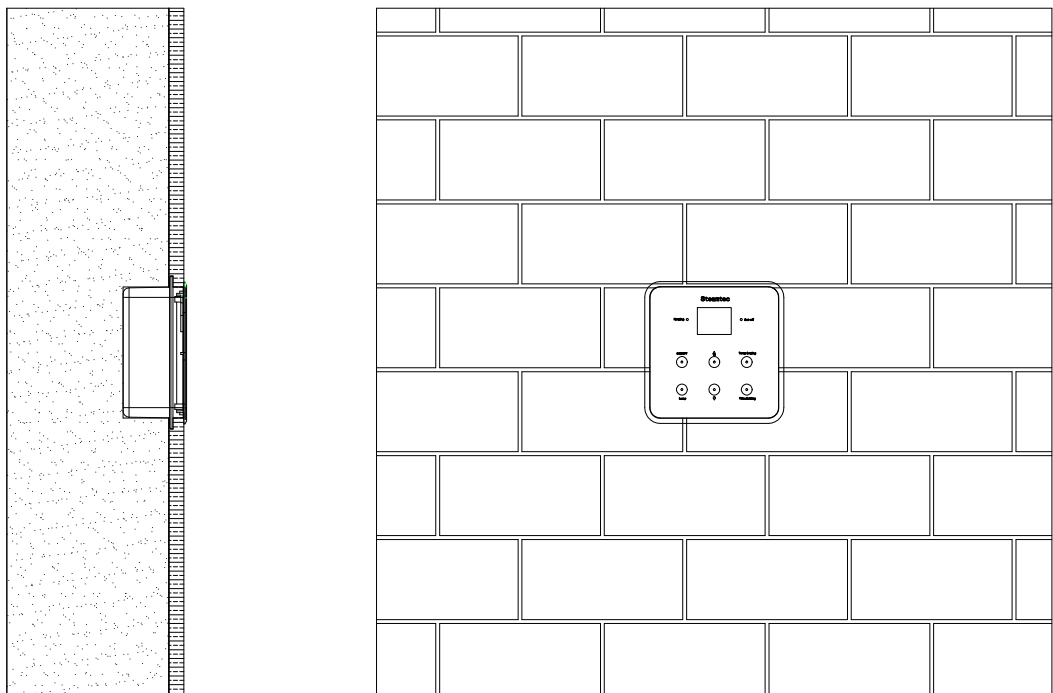

Forth step: insert the controller into the housing box



Real picture

Figure 9 Controller installations

6.4.3. Installation of temperature sensor

The temperature sensor is used to measure the temperature inside the steam room, so that the generator can work automatically according to the pre-set temperature and maintain the room temperature constant.

The installation height of the sensor should be about 1.2 –1.5 m from ground. Please drill a hole (diameter 16mm), and then nail down the sensor in the steam room (Refer to figure 10), pull the sensor wire through the conduit then connect to the central function box.

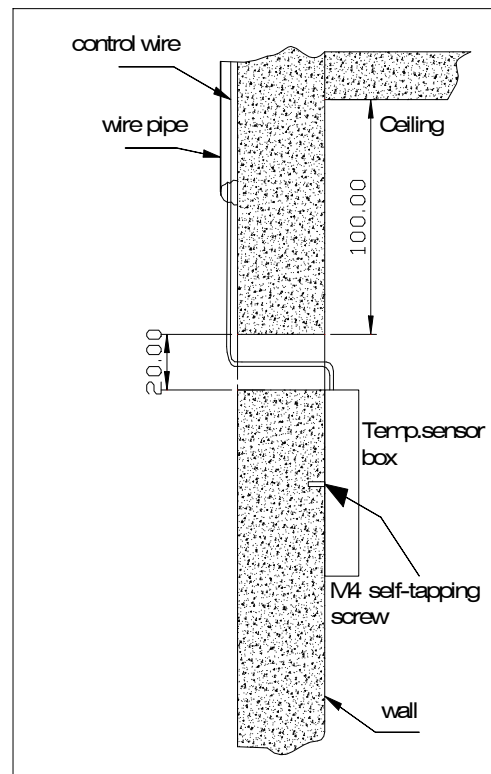

Figure 10 Temp sensor installations

6.5. Installation of pipeline



3kw ~ 13.5kw

- ① Service hole 1/2"
- ② Steam outlet
3kw~6kw: 1/2"
7kw~13.5kw: 3/4"
- ③ Safety valve 1/2"
- ④ Water inlet 1/2"
- ⑤ Drain outlet 3/4"
- ⑥ Power supply for drain valve

Figure 11 3kw- 13.5kw pipe connection



15kw ~ 24kw

- ① Service hole 1/2"
- ② Steam outlet 3/4"
- ③ Safety valve 1/2"
- ④ Water inlet 1/2"
- ⑤ Drain outlet 3/4"
- ⑥ Power supply for drain valve

Figure 12 15kw-24kw pipe connection

i. Water Inlet:

First connect the water magnetizer (if applicable) to the water inlet solenoid valve. Then please use a 1/2" flexible stainless steel hose to connect the other side of the water magnetizer and the water supply pipeline. Do not connect to metal water supply pipeline directly which may damage the water inlet valve.

Attention: Only use cold water supply.

ii. Drain Outlet

Please use 3/4" copper pipe or stainless steel pipe to connect the drain outlet and the drain pipeline of the house. The drain pipeline should be installed with small angle so as to help residual water in the steam generator flow to the drain pipe.

Attention: Don't use locking pliers to over tight the drain pipe connection. Just make sure it without leakage under Teflon tape sealing. The water come out from the steam generator will over 100°C. Don't use the plastic pipe/acrylic pipe/FRP pipe or other similar material pipe.

iii. Steam outlet

Please use copper or stainless steel pipe to connect the steam head and the steam outlet pipe of the generator. The pipe should be less than 3 meters long and minimize the number of elbows, otherwise heat isolating methods should be implemented.

- For 3KW-6KW steam generator, steam outlet is 1/2", please **AT LEAST** use 1/2" steam pipe, must be stainless steel pipe or copper pipe.
- For 7KW-13.5KW steam generator, steam outlet is 3/4", please **AT LEAST** use 3/4" steam pipe, must be stainless steel pipe or copper pipe.
- For 15KW-24KW steam generator, steam outlets are **TWO** 3/4" , please **AT LEAST** use **TWO SEPARATE** 3/4" steam pipes, don't cross the two steam pipes, must be stainless steel pipe or copper pipe.

Attention: Please **MUST** choose right diameter steam pipe, as if the pipe size is smaller than our instruction, it may cause the steam generator internal pressure to increase suddenly which may damage the steam generator and have safety risk.

iv. Safety Valve

It's to release the pressure of steam generator, use 1/2" copper pipe or stainless steel pipe to connect the safety valve and the drain pipeline of the house. Please don't block it.

v. Steam Head

The steam head should be about 300mm from the ground and at least 150mm from customer seats. Please apply silicone glue on the steam pipe nipple and back of the steam head, and then screw the steam head on to the steam pipe nipple. Please refer to figure 13, the Aromatherapy reservoir should face upwards.

vi. Service hole

Can be used as maintenance hole or another steam outlet 1/2". How to do maintenance, please refer to Chapter Warranty And Services.

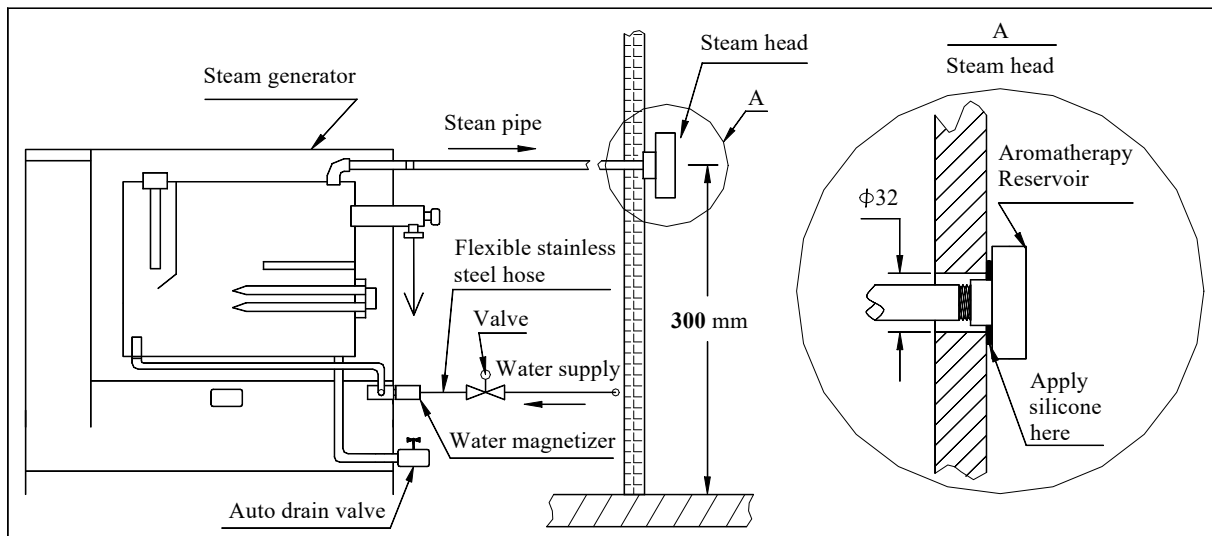

Figure 13

6.6. Installation of electrical circuits

Cautions

- All circuits should be installed by licensed electricians and conform to local and national codes.
- Power supply must be cut off before installation, maintenance and repair. Press the on/off button on the controller can **NOT** cut off the power supply.
- No additional power supply or wire is allowed to connect to the generator. Do **NOT** connect the earth wire to the null wire.
- Only the original parts and elements from our factory are allowed to be used in installation, operation, maintenance and repair.
- After the installation of the pipeline and electrical circuits, careful checking must be performed before switch on the generator.
- The generator has been carefully installed, checked and tested in factory, thus user only need to install the power wire.
- The power supply should be 215-240V or 380-415V, 50/60Hz, please refer to the nameplate of the generator.
- The selection of fuse and breaker must strictly follow the data in table 2.
- Choose the suitable power wire according to table 2 and local codes.
- Take off the back cover of the generator, insert the 3-core (1 live, 1 null and 1 earth) power wire (single phase, 215-240V, 50/60Hz) or 5-core (3 lives, 1 null and 1 earth) power wire (three phases 380-415V, 50/60Hz) into the hole at the back of the generator case and connect to the correct terminal. (Refer to figure12-13). After that, tightening the wire terminal to prevent accident that wire may be fall out.

6.6.1. Power Supply

Single phase, 215-240V, 50/60Hz power supply:

Connect the live wire to the terminal labeled as “L”; connect the null wire to the terminal labeled as “N” ; and connect the earth wire to the terminal labeled as “⊕”. Please see figure 14.

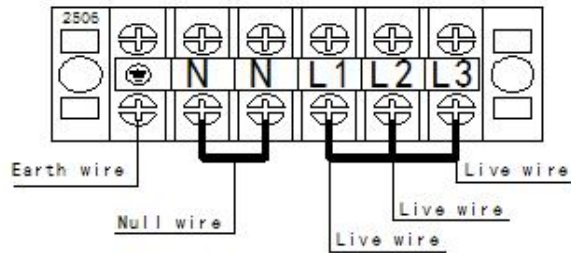

Figure 14 Single phase, 215-240V

Three phases, 380-415V, 50/60Hz power supply :

Connect the 3 live wires to the terminal labeled as “L1”, “L2” and “L3” respectively; connect the null wire to the terminal labeled as “N”; and connect the earth wire to the terminal labeled as “⊕”. Please see below figure 15.

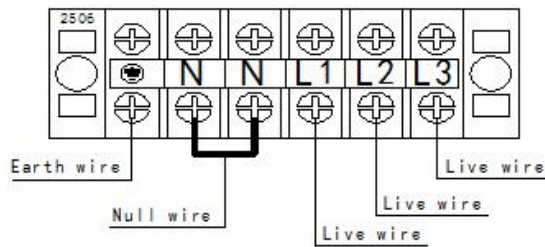
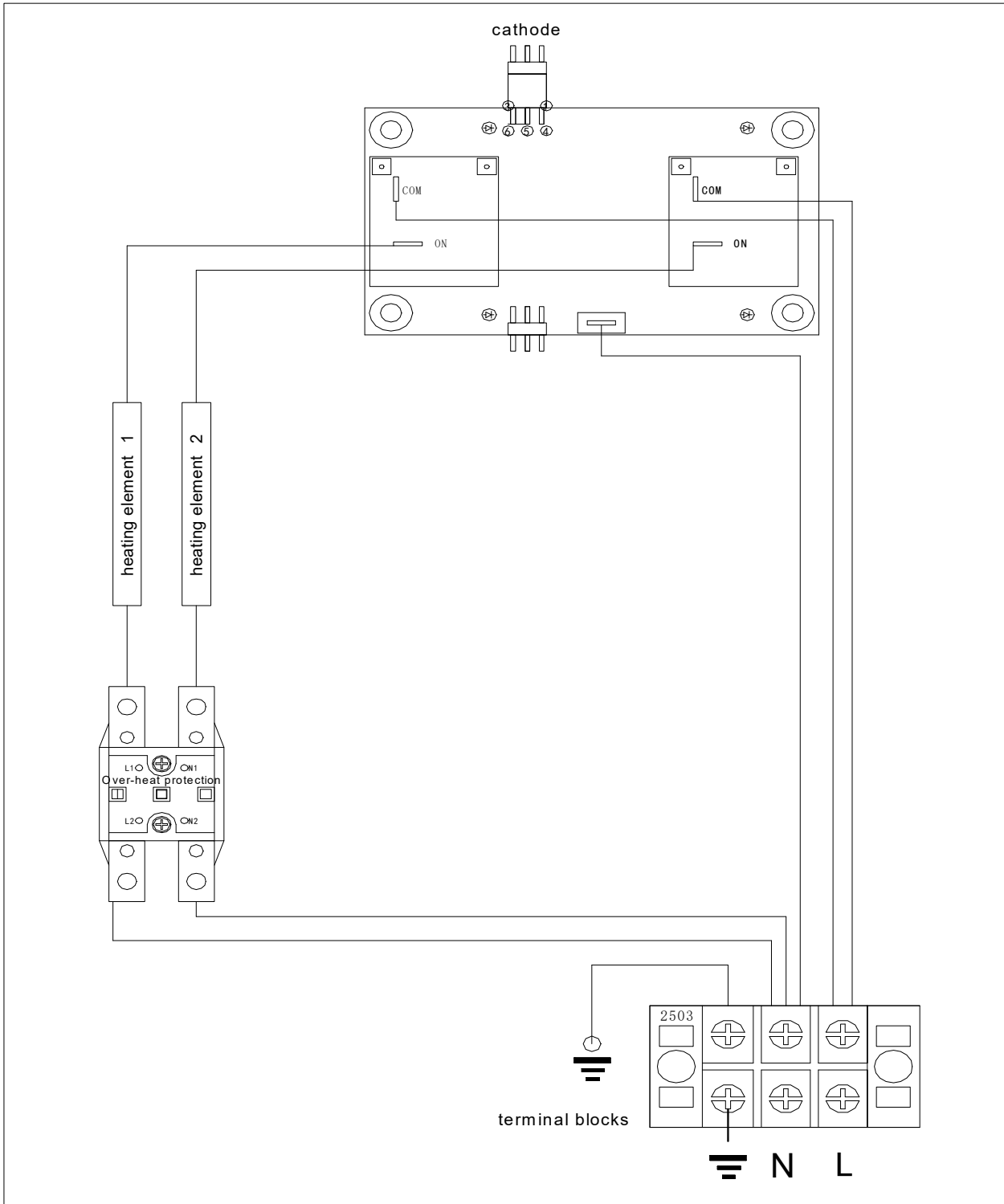

Figure 15 Three phases, 380-415V

6.6.2. Wire Diagram



AIO 3KW, 4KW European 215 ~240 V single phase

Figure 16

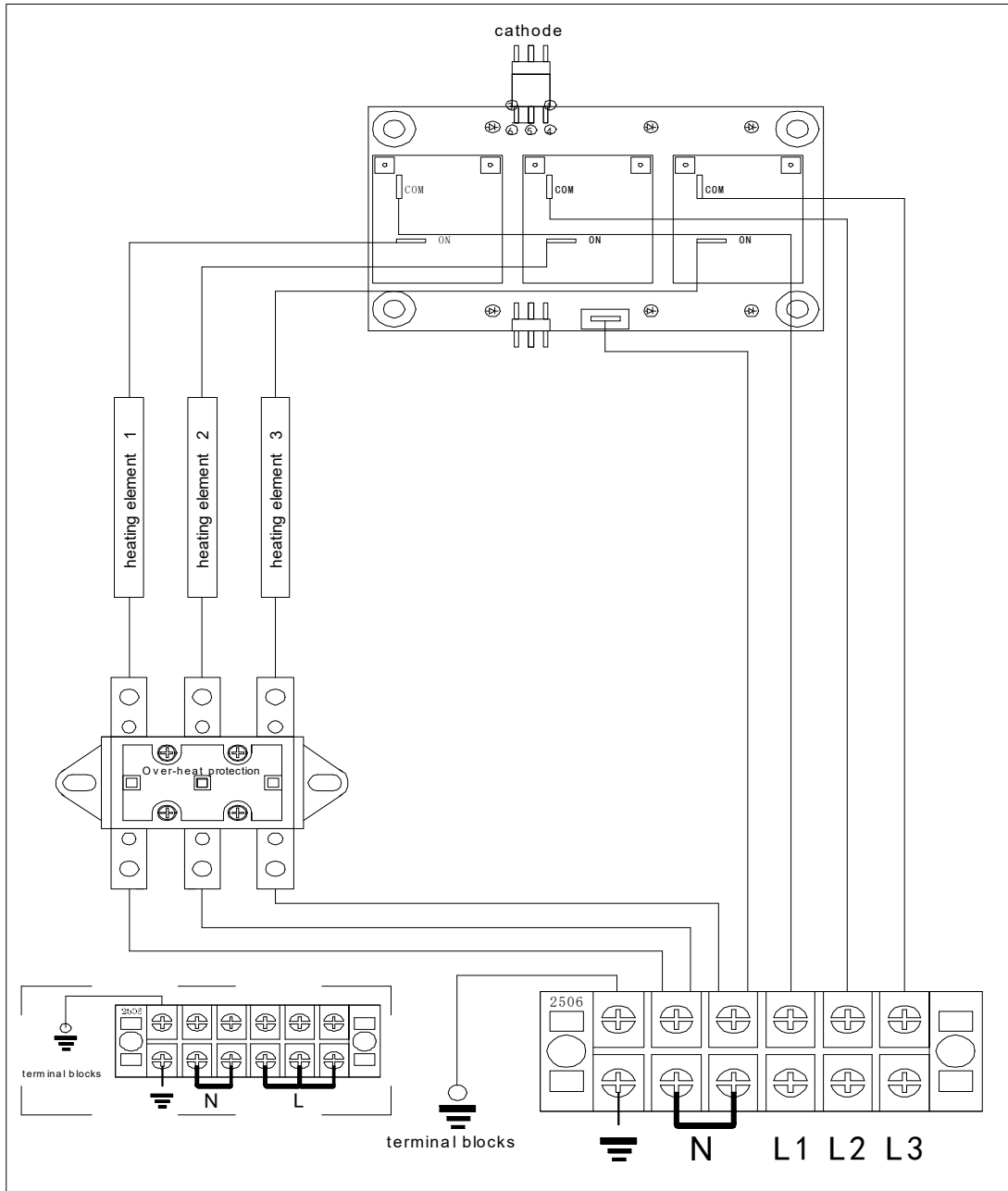

AIO 4.5kw 5kw 6kw 7kw 7.5kw European 215 ~240V Single Phase or 380 ~415V 3Phases

Figure 17

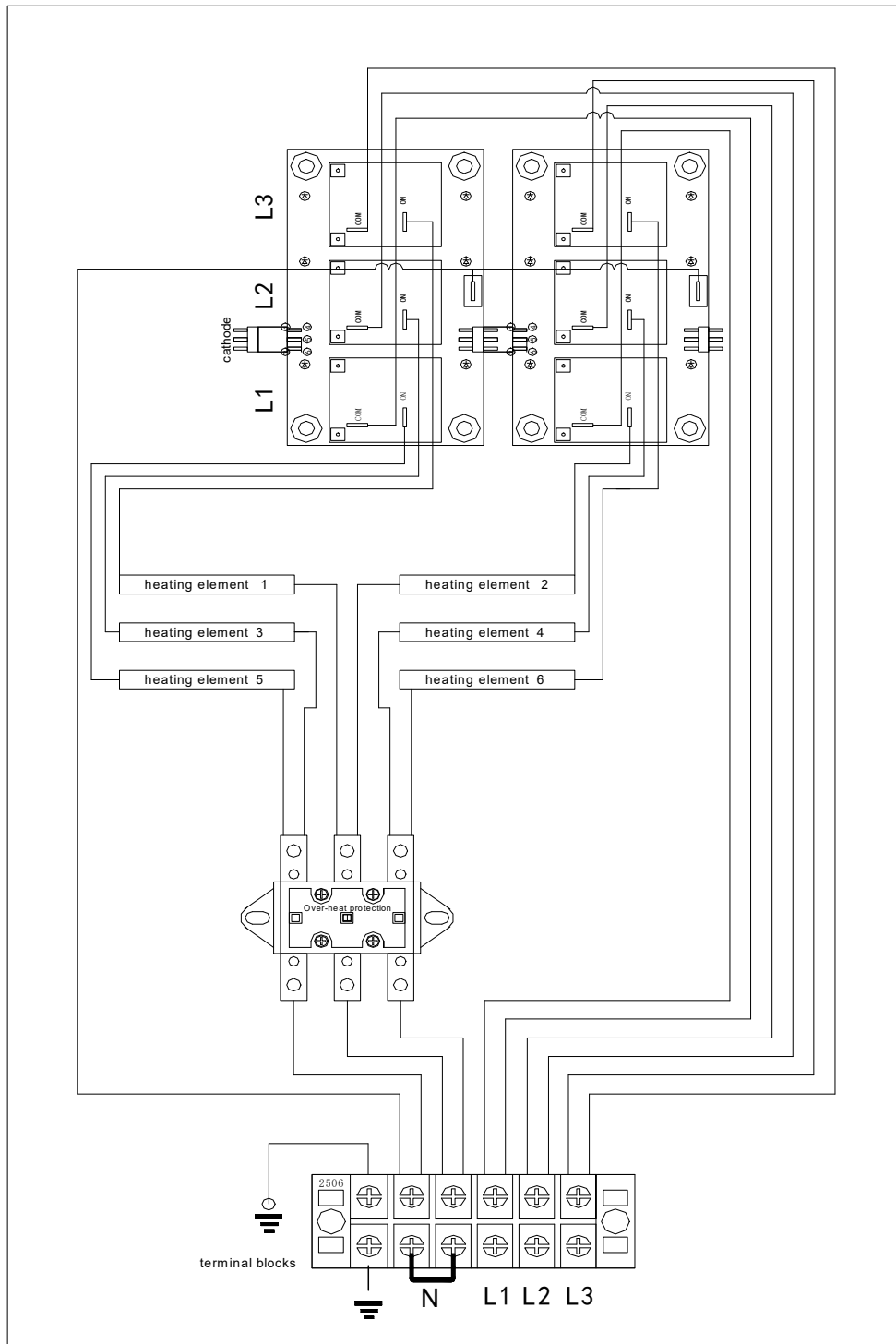

AIO 9kw 10.5kw 12kw 13.5kw European 380 ~ 415V 3 Phases

Figure 18

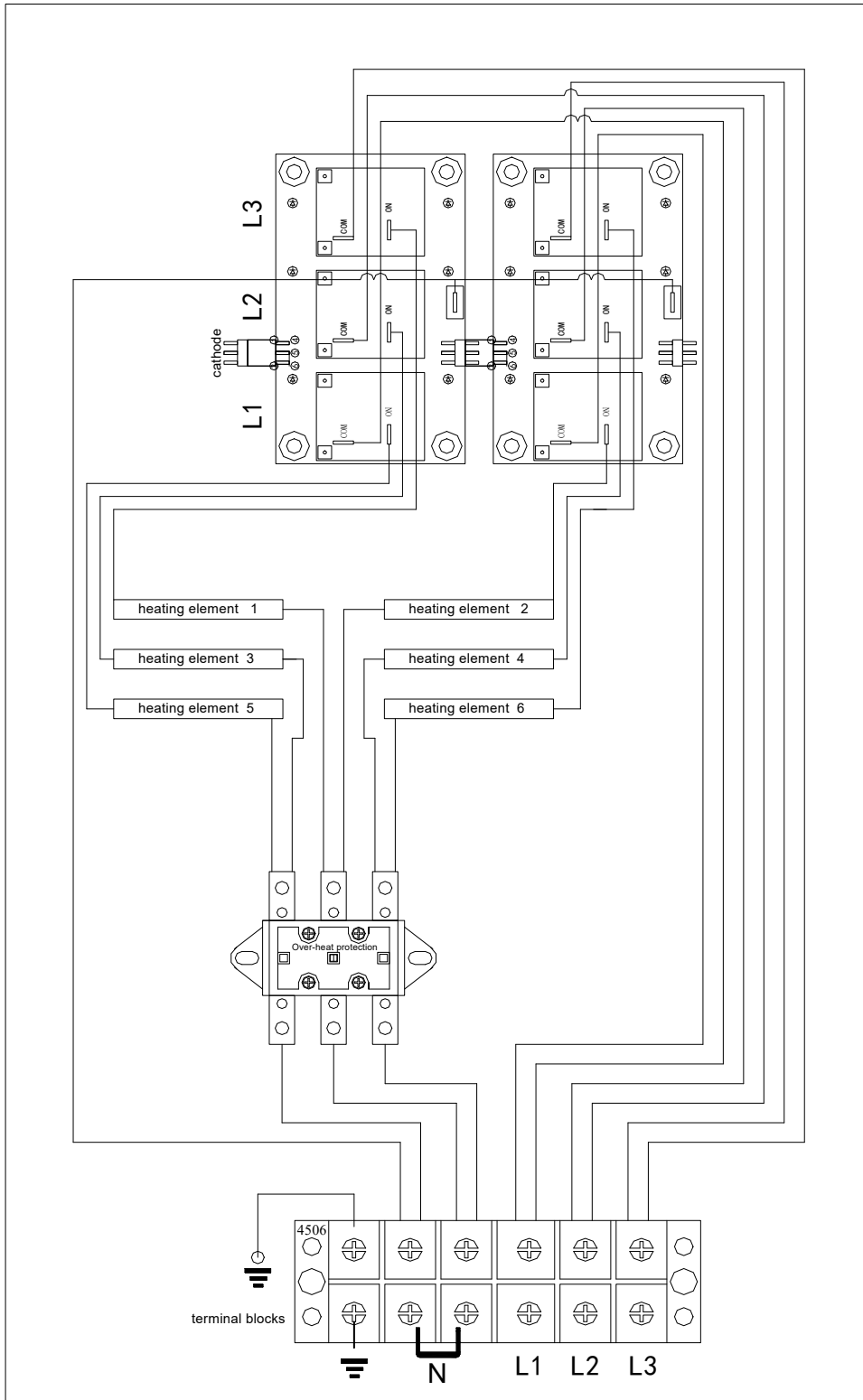

AIO 15kw European 380 ~ 415V 3 Phases

Figure 19

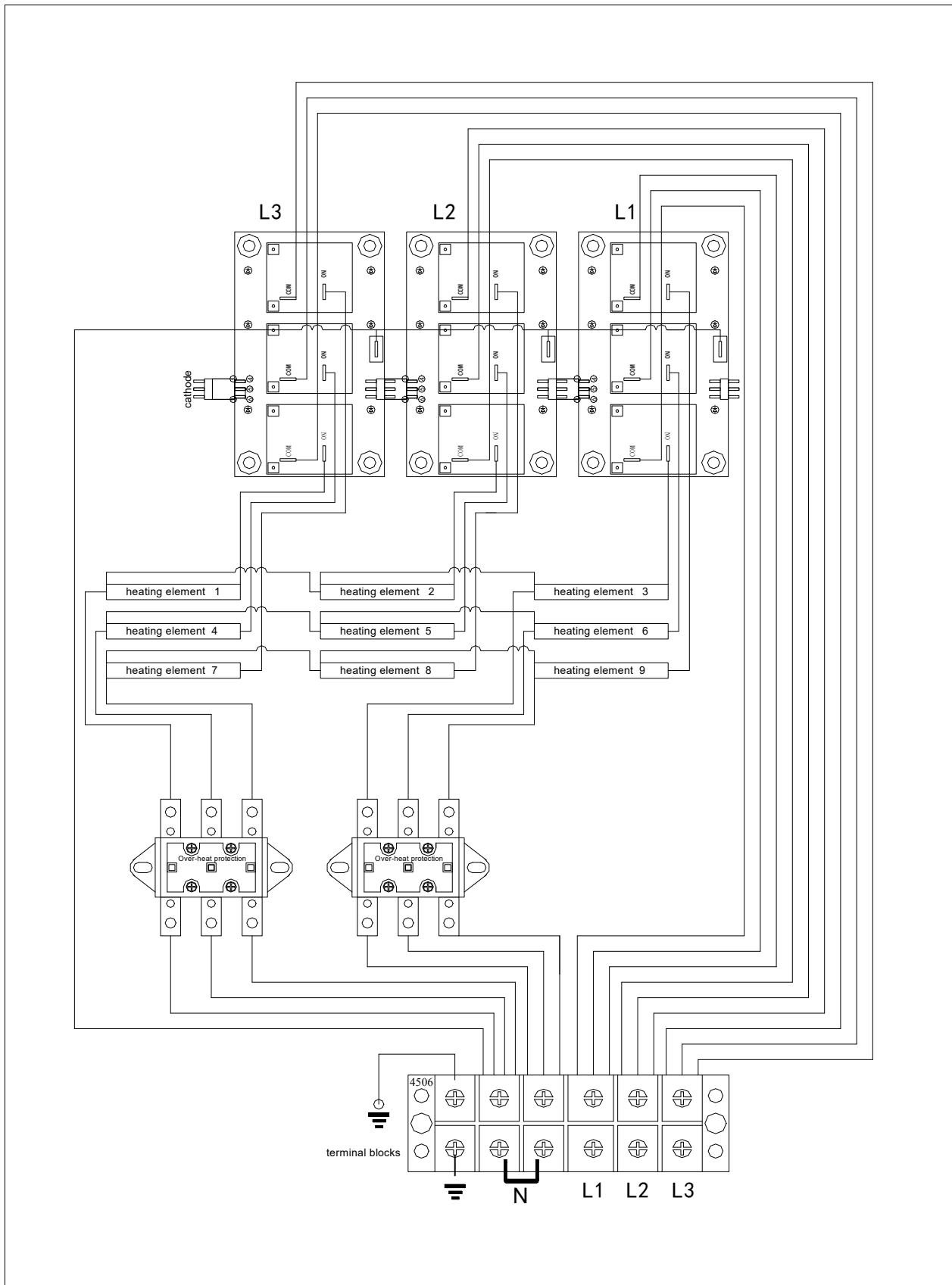

Figure 20 AIO 16.5kw 18kw 22.5kw 24kw European 380 ~ 415V 3 Phases

7. Functions And Operation

7.1. Controller display items

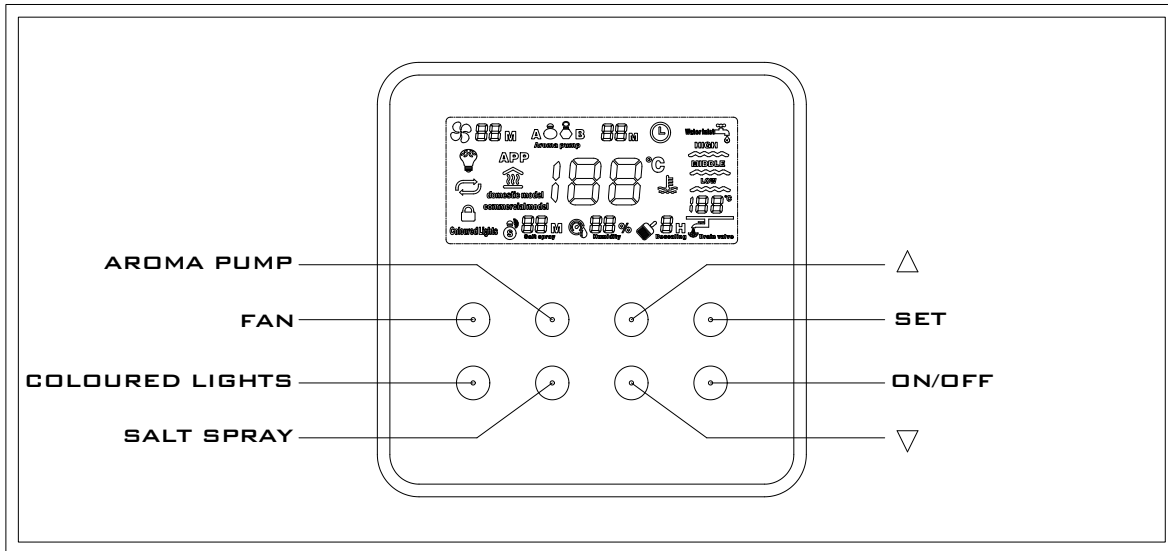
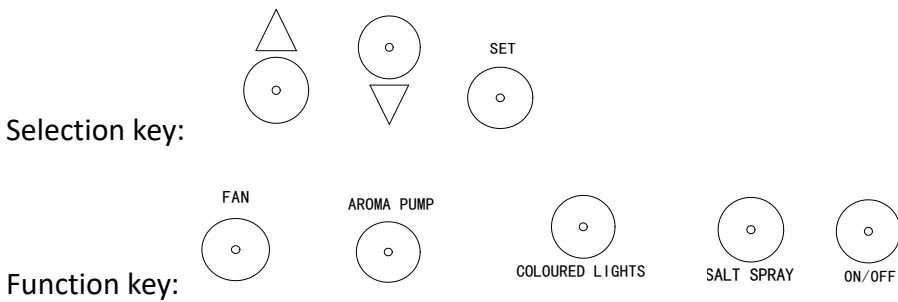

Figure 21 AIO Controller

Each first touch is for waking up the touch panel.



Working time range: 1~60 minutes or continuous (CH). The default working time is 45 minutes.

Temperature setting range: 35~60° C. The default temperature is 43° C.

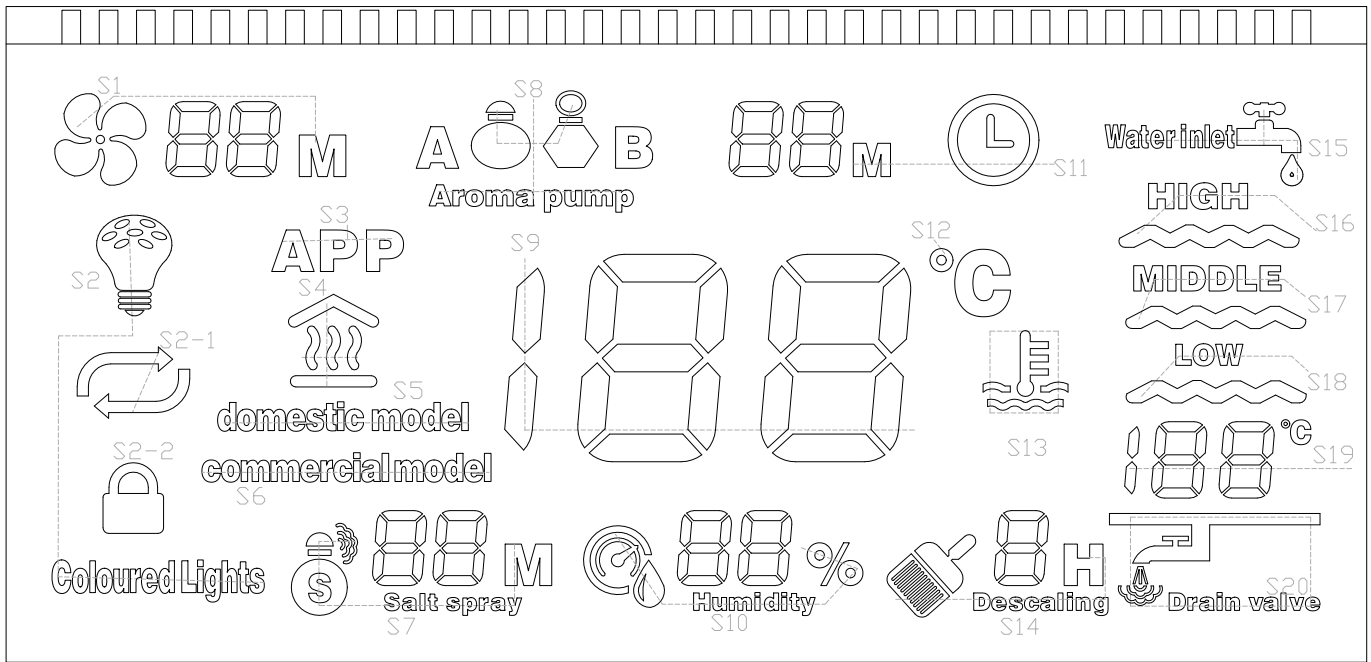

Figure 22 Controller display

S1	Exhaust fan	S7	Salt spray	S14	Descaling
S2	Colored lights	S8	Aroma pump	S15	Water inlet valve
S2-1	Change colors automatically	S9	Temperature instructions	S16	High water level
				S17	Middle water level
S2-2	Lock the color	S10	Humidity instructions	S18	Low water level
S3	APP	S11	Working time	S19	Water tank temperature
S4	Heating instructions	S12	Celsius degree		
S5	Domestic model	S13	Heat preservation instructions	S20	Drain valve
S6	Commercial model				

Table 4

S1 Exhaust fan:



Fan ON/OFF button

The working time setting is from 1-60 minutes, after time arrived, will stop working automatically. Default time is 5 minutes.

The time show on the display is the remaining working time.

S2 Colored lights:

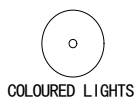

Colored lights on/off button

Change colors automatically(S2-1): touch , move the cursor on screen to colored lights,

press  to choose the work model “ change colors automatically”, then wait for 5 seconds, it will back to home page.

Lock the color (S2-2): the same way as setting (S2-1).

S3 APP: Steamtec Sauna in AppStore

Connect well the WiFi kit to the central function box. Make your phone and steam generator WiFi kit under the same wireless local area network (WLAN). Open the App in your iPhone or Android phone, then you can operate the steam generator by your Phone now. More information, please browse “Steamtec Sauna” App operation guide.



After your Phone connect well to steam generator, the all-in-one controller screen will show “App”.

S4 Heating instructions:

S4 lights: steam generator is heating

S5 Domestic model:

S5 lights: steam generator is under domestic model. (Change to commercial model, please cut off the general power supply, then switch the button inside the central function box).

S6 Commercial model:

It is special for commercial place like spa center or sauna center. Under commercial model, water tank always keep the water temperature at 80°C, once the customer go into the steam

room, press the “fast steam” controller, the steam will come out in 30 seconds, runs 30 minutes, it back to stand by (Heat preservation state).

S6 lights: steam generator is under commercial model. (Change to domestic model, please cut off the general power supply, then switch the button inside the central function box).

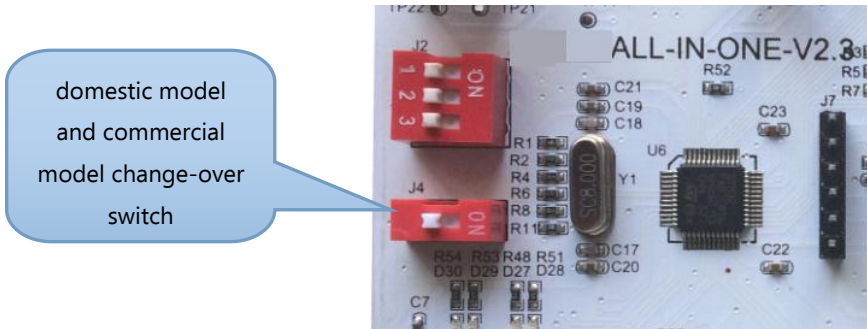



Figure 23

S7 Salt spray:

S7 lights: salt spray is on. Working time is from 1~60 minutes and “CH”(non stop). The default working time is 30 minutes.

S8 Aroma pump:

S8 lights: aroma pump is on. There has A/B aroma pump with 2 kinds of aroma oil. Change

A/B pump at  . Pump’s default working time is 5 seconds, then waiting time is 5 minutes. The working time is non-adjustable. If you like the more heavy fragrance, please restart it again and again.

S9 Temperature instructions:

S9 shows the steam room temperature value. Set the temperature at  .

If the steam room temperature lower than 6°C, controller display shows “=L”. If the steam room temperature higher than 60°C, controller display shows “=H”. Under “=L” or “=H”, the heating elements will not work.

S10 Humidity instructions: (not in standard equip)

S10 Humidity sensor default value is 60%. Setting arrange: 60~99%. Adjust it by  .

If steam generator is with humidity sensor, the steam generator will stop when the humidity reach the setting value. (Notice: the humidity sensor is not in standard equip. Without humidity sensor, steam generator works depends on the temperature sensor. If steam generator works with humidity sensor, it will stop when the humidity reach the setting value. If the humidity value lower 6 % than setting value, steam generator will start to heat again. If no need humidity sensor, please pull out it from the control center box. Then turn off the control center box and restart.

S11 Working time:

S11 timing functions: the default value is 45minutes. Working time is from 1~60 minutes and “EH” (non stop).

S12 Celsius degree:

S12 shows the steam room temperature in Celsius degree.

S13 Heat preservation instructions:

S13 lights: shows the room temperature reaches 2°C higher than your setting value, then all heating elements stop working, steam generator under heat preservation state.

S14 Descaling:

S14 lights: steam generator is off, going into descaling model. Descaling time is from 0~8 hours. “0” means automatically drain immediately, “1~3H” is waiting time, then drain, non descaling function, “4~8H” is descaling model. Under “4~8H”, after you off the steam generator, it will automatically pump descaling liquid into water tank for soaking. For example, if you set 6 hours, it will soak with descaling liquid for 6 hours. When time reaches, steam generator will start to drain, flushing, and then power off.

Pump working time:
 1----30seconds
 2----60seconds
 3----90seconds
 It was set well in factory according to the different power of steam generator



Figure 24

S15 Water inlet valve:

S15 lights: shows steam generator is inflow

S16 High water level:

S16 lights: shows the water level in water tank reach to high level.



S17 Middle water level:

S17 lights: shows the water level in water tank reach to middle level.

S18 Low water level:

S18 lights: shows the water level in water tank reach to low level.

S19 Water tank temperature:

S19 lights: shows the water tank temperature, if it is over 115 °C, steam generator go into protection state, controller screen shows “”, steam generator stop heating. When the temperature lower than 100°C, steam generator start to work again, (if “” comes, please also contact the dealer for maintenance).

S20 Drain valve:

S20 shows the working state of drain valve. The drain valve light “ON”, mean it is draining the water now.

7.2. Auto Functions

i. Auto filling:

Inlet valve will open automatically once the system is started and fill in water automatically until the water level reaches maximum level. If water level is still lower than the minimum water level 10 minutes after, it indicates faults of the water supply system, so all heating

elements will stop working. If the screen display “”, it means it’s filling in water.

ii. Auto heating up by sections:

Generator will compare the measured room temperature with the setting temperature and then decides the number of working heating elements.

iii. Auto water supplementing:

If the water level is lower than the desired level when operating, auto water supplementing

function will be on and open the inlet valve, the screen will display “”. Once the water level reaches the desired level, auto water supplementing function turns off. If water level is lower than the desired level 3 minute after the water supplementing order is given, it indicates faults of the water supply system, so all heating elements stop working.

iv. Auto drainage:

If the Descaling time is set as “0”, and after the steam generator is off, system will drain

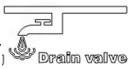
automatically and displays ‘ Drain valve” on the screen. The drainage valve will be turned on to drain. If the Descaling time is NOT set as “0”, please ref to “S14 Descaling”.

8. Maintenance

- As leakage of the steam will damage the equipment. To prevent any hazard, steam generators, steam head, parts and pipe line connections should be checked regularly.
- Clean the solenoid valve, magnetizer and all the other sets in the pipe line regularly according to the local water quality and usage of the steam generator.
- When operate, check the equipment to see whether it’s over heated, check the stability and corrosion of all the wire plugs.

i. Replace the heating elements:

Switch off the steam generator and remove the element access cover when the generator completely cools down. Label the wires connect to the heating elements which need to be replaced and plug out the wires. Screw the heating elements out. Clear the scale in the water tank and screw in the heating elements after putting the rubber rings on them (airproof gasket should be pressed firmly without reversion). Plug on the wires, make sure the heating elements are properly connected before put on the element access cover.

ii. Replace the main board:

The main board is inside the central function box. If need to replace the main board, please contact your dealer.

iii. Replace the sub-board:

Switch off the steam generator and remove the U shape cover when the generator completely cools down. Unplug all the wires on the sub-board. Label all the wires on the relay and remove the sub-board. Install the sub-board back carefully.

iv. Replace the solenoid water inlet valve:

Switch off the steam generator and disconnect from the power and water supply. Remove the water inlet, steam outlet and draining pipelines after the generator completely cools down. Then please lean the steam generator to remove the base panel. After that, please take off the soft pipes, wires and screws so that the faulty valve could be removed. Finally please install the replacing valve carefully.

v. Replace the water level sensor:

Switch off the steam generator and remove the small cover on the equipment when the generator cools down. Special care should be taken to the plugs of the water level sensor corresponding to the blue wire, the red wire and the white wire respectively. Take off all the wires, screw out the water level sensor, and screw in the new water level sensor until the bottom of the plastic nut reaches the same height as the old one. Finally reconnect the wires (all wire must be plugged back to the right place.).

- Cut off the power supply before any maintenance.
- Test the equipment after maintenance.

9. Troubleshooting

Repair can only be performed by qualified professionals, for more services or technical helps please contact the dealer.

AIO steam generator has self-diagnose function, and some common faults will be displayed on the screen if occur.

Code	Meaning	Diagnose and Solution
-L	Temperature measured by temperature sensor is below 6 °C	Check whether the room temperature is below 6 °C, the code should disappear after the room temperature reaches 6 °C. Otherwise check the connection of the sensor.
-H	Temperature measured by temperature sensor is higher than 60 °C	Check whether the room temperature is above 60 °C, the code should disappear after the room temperature drops below 60 °C. Otherwise check the connection of the sensor.
-E	Water supply or water fill in faults, the heating elements will not heat up or stop heating up.	Check whether the water inlet solenoid valve works, check the valve on the water pipeline or water supply source, check the magnetizer (if have), check whether the water level sensor connection cable is rusted or not connected. If any problem on above items, please clean, replace or process the problem, then restart the machine, to see if you can feel the water inlet or not.
EE	Communication fault between the controller and circuit board on the central box.	Please check the connection cable, if any turn off or short off, if the connection of the wire is good or not.
d or dd	Time runs out or pressed the "ON/OFF" button, machine stop working and go in the auto drain progress.	Normal

Table 5

A manual resetting high temperature control switch is installed in the steam generator for over-heat protection. If temperature of inner tank exceeds 115 °C accidentally, the switch will automatically disconnect power supply to heating element. In this case, it is necessary to disconnect the power supply to steam generator, and then carefully check heating elements, water level sensor, relay on sub-board and water supply pipeline after steam generator completely cool down. **The temperature switch could only be manually reset after the fault has been located and solved.**

Diagnosing procedure:

- i. The AIO controller can show the status of the steam generator working.
 - ii. If the generator can fill in and drain out water properly but does not heat up, please check the connection wire between main circuit board and the sub-board, the relays on sub-board, and heating elements.
 - iii. If water comes out from the steam outlet pipe seriously, please clean or change the outlet solenoid valve.
 - iv. If the system keeps on heating up even if the current temperature is more than 2 °C above the setting value with the indicator on, carefully test the relays on the sub-board and change the faulty ones, or change the whole sub-board.
- The above fault diagnosis and troubleshooting can refer to the function of the following main board indicators.

D24: 12V power supply	D18.19.20: heating elements	D11: aroma pump A
D34: 5V power supply	D14: descaling	D12: Aroma pump B
D22: drain OFF	D15: salt spray generator	D27.28: APP
D26: drain ON	D16: Fan	D29:30:Controller
 - Please refer to the circuit and connection diagrams for diagnosing and repair.
 - Do cut off the power supply before repair.
 - If problems still cannot be solved by the procedures listed above, please contact the dealer.

10. Warranty And Services

Product: TOLO-AIO	under work with descaling pump	without maintenance
Controller	2 years	2 year
Heating element	2 year	1 year
Steam generator body	5 years	1 year
Water level sensor	2 year	1 year
Temperature sensor	2 year	1 year
Control box	1 year	1 year
Drain valve	1 year	1 year
Fast steam controller	2 years	2 years
WiFi system	1 year	1 year
Music system	1 year	1 year
Aroma system	1 year	1 year
Descaling system	1 year	1 year
LED light system	1 year	1 year
Exhaust Fan	1 year	1 year
Salt generator	1 year	1 year

Table 6 AIO warranty time

Notes:

- (1) Warranty period will count from the ex-factory date of the steam generator.
- (2) Limited free warranty only including provide free spare parts and our remote services, not including any other direct or indirect costs / losses.
- (3) Limited warranty is offered to all customers. Any quality problem will be covered according to above file. Please provide the maintenance record (Regular descaling records) when you ask for warranty.
- (4) The controller warranty for 2 year is under install it outside the steam room. Inside the steam room, controller warranty is for 1 year.
- (5) Our company has the right to decide whether to repair or to change. Approval must be obtained from our company before shipping back the product. The customer has to pay for the transportation fee and any parts fee beforehand.
- (6) Any clause mentioned in the manual is not covered by the warranty.
- (7) This warranty does not cover any defect, malfunction or failure caused by, or resulting from unauthorized installation, maintenance and repair; improper power supply; and any action which violates the manual.
- (8) Damage caused by accident, misusing of chemistry products, or any other reason which are beyond our company's responsibilities will not be covered. Any product whose label, nameplate has been removed, altered, damaged is not covered either.
- (9) Using in a salty environment or any other extreme, corrosive condition is not covered by the warranty.

- (10) After the free warranty period, services are still available if all cost is covered by the customer.
- (11) Our company is not responsible for any direct or indirect damage caused by the generator.
- (12) Please contact our company for further information and more details.
- (13) Tips for maintenance:
if you buy the AIO auto descaling device, please follow its guideline, if not, please follow below manually descaling methods:

How to descale Tolo Sauna Steam Generator?

There is a service hole on top of steam generator, you can put descaling liquid through service hole, and let it stay in water tank for 4-8 hours, then flush.

How frequently should descaling be done?

- *For home use: at least once per month
- *For commercial use: at least once per week

What descaling liquid can be used?

TOLO acid;
Vinegar or lemon juice, mix with water and make concentration around 10%;
Or can use edible acid cleaning solution or powder.

11. Appendix: Parameter Of Special Models

Model	Power (Kw)	Voltage (V) / Current (A)	Power line size (N*mm ²)	Fuse or breaker (A)
AIO-90	9.0	215-240/41	3*10.0	60
AIO-105	10.5	215-240/48	3*10.0	60
AIO-120	12.0	215-240/55	3*10.0	100

Table 7

Notice:

Notice: We do not recommend customer to choose special models. However we could still specialize our system for customers if they have special needs due to restrain of space or power supply.

More information you need, please feel free to contact us at info@tolosauna.com

MAINTENANCE RECORD(Regular descaling records)

Model : _____

<u>Date</u>	<u>Person</u>	<u>Detail description</u>