

# IKI

KIUKAISTA KIUKAIN

## Installation instructions



### IKI Wood burning stoves

Mini-IKI  
Mini-IKI Plus  
Original IKI  
Original IKI Plus  
Maxi-IKI  
Maxi-IKI Plus  
Löyly-IKI

9/2016

- The stove must not be used for any other purpose than heating a sauna, for example drying clothes, using it as a heater in a building site, etc.
- Covering the stove during use or when it is hot is strictly prohibited.
- Throwing sea water or other salty water on the stones is prohibited and will cause the warranty to become void and will cause early rusting.
- Beware of the blast connection, hatch, or other metal surfaces of the stove and the stones, THEY MAY BE HOT! Always wear protective gloves, mittens, etc. With children, take special precautions in the sauna!

In addition to this instruction, the EU heater standard 15821, local fire rescue authorities rules and regulations must be taken into account when installing and using the stove.

## **NOTE!**

**Beware of the sharp edges of the mesh and other parts. Always wear protective gloves and a long-sleeved shirt when handling the mesh of the stove and piling in stones.**

## **Contacts**

### **Technical support**

(mon-Fri 9-16)  
+358 (0) 600 550 133  
(1,49 €/min + I.c.c.)  
tuki@ikikiuas.fi

### **IKI-Kiuas Ltd.**

Hakaniemenkatu 11  
00530 Helsinki  
ikikiuas@ikikiuas.fi

### **Vallila pick up storage**

Pälkäneentie 5  
00510 Helsinki  
vallila@ikikiuas.fi

### **Production**

Niilontie 10  
76150 Pieksämäki  
tuotanto@ikikiuas.fi

## Table of contents

Table of contents.....	2
1. Contents of delivery .....	6
2. Installation of the stove.....	7
2.1 Mini-IKI, Original IKI and Maxi-IKI.....	7
2.2 Setting the stones into stove:.....	8
2.3 Plus version installation instructions.....	9
2.4 Modifying a chimney connection to a non-standard height.....	10
3. Safety distances to flammable structures.....	10
3.1 Reducing the safety distances .....	10
3.2 Protective base for the stove .....	11
4. Connection heights.....	11
5. Model table .....	12
6. Instructions for using the stove.....	12
6.1 Initial load and lighting the fire .....	12
7. Troubleshooting .....	13
8. The water quality for the stove .....	13
9. Dimensional drawings .....	14
10. Sweeping instructions .....	14
11. Ventilation of the sauna and getting compensation air.....	15
11.1 Tips for ventilation.....	15
11.2 Automatic ventilation .....	15
11.3 Using a chimney ventilator and several furnaces in the same room .....	15
12. Warranty.....	17

<b>CE</b>		
IKI-Kiuas Ltd. <b>15</b>		
<b>EN 15821:2010</b> NB 2450 AVCP3		
Multi firing sauna stoves fired by solid wood fuel		
Mini-IKI / (Plus)		DoP 07122015
Fire safety (initiation, risk to adjacent elements)		Passed
Safety distances to combustible materials*	to the back to the sides up to the ceiling	100 mm 100 mm 1100 mm
Emission of combustible products		Passed
Surface temperature		Passed
Release of dangerous substances		NPD
Cleanability		Passed
Flue gas temperature (average)		346 ° C
Mechanical resistance		Passed
Sauna room heating output		16,6 kW
- carbon monoxide emission 13 % O <sub>2</sub>		Passed
- CO-emission 13 % O <sub>2</sub>		(867 mg/ m <sup>3</sup> )
- carbon monoxide emission (%) at 13 % O <sub>2</sub>		Passed
- CO-emission (%) 13 % O <sub>2</sub>		(0,069%)
- total efficiency		Passed (74,2%)
- flue draught		12 Pa
- refuelling loads		2,9 kg
- flue gas mass flow		17,7 g/s
Durability		Passed
Flue gas temperature (max.)		588,9 °C

\* Follow the safety information in the installation instructions

<b>CE</b>		
IKI-Kiuas Ltd. <b>15</b>		
<b>EN 15821:2010</b> NB 2450 AVCP3		
Multi firing sauna stoves fired by solid wood fuel		
Original IKI / (Plus) Maxi-IKI / (Plus)		DoP 10252015
Fire safety (initiation, risk to adjacent elements)		Passed
Safety distances to combustible materials*	to the back to the sides up to the ceiling	100 mm 100 mm 1100 mm
Emission of combustible products		Passed
Surface temperature		Passed
Release of dangerous substances		NPD
Cleanability		Passed
Flue gas temperature (average)		411,7 °C
Mechanical resistance		Passed
Sauna room heating output		15,1 kW
- carbon monoxide emission 13 % O <sub>2</sub> - CO-emission 13 % O <sub>2</sub>		Passed (1242 mg/ m <sup>3</sup> )
- carbon monoxide emission (%) at 13 % O <sub>2</sub> - CO-emission (%) 13 % O <sub>2</sub>		Passed (0,10%)
- total efficiency		Passed (65,2%)
- flue draught		12 Pa
- refuelling loads		3,5 kg
- flue gas mass flow		17,7 g/s
Durability		Passed
Flue gas temperature (max.)		539,2 °C

\* Follow the safety information in the installation instructions

<b>CE</b>		
IKI-Kiuas Ltd. <b>16</b>		
<b>EN 15821:2010</b> NB 2450 AVCP3		
Multi firing sauna stoves fired by solid wood fuel		
Löyly-IKI		DoP 2030
Fire safety (initiation, risk to adjacent elements)		Passed
Safety distances to combustible materials*	to the back to the sides up to the ceiling	100 mm 100 mm 1100 mm
Emission of combustible products		Passed
Surface temperature		Passed
Release of dangerous substances		NPD
Cleanability		Passed
Flue gas temperature (average)		386 °C
Mechanical resistance		Passed
Sauna room heating output		17,2 kW
- carbon monoxide emission 13 % O <sub>2</sub> - CO-emission 13 % O <sub>2</sub>		Passed (1439 mg/ m <sup>3</sup> )
- carbon monoxide emission (%) at 13 % O <sub>2</sub> - CO-emission (%) 13 % O <sub>2</sub>		Passed (0,12%)
- total efficiency		Passed (65,2%)
- flue draught		12 Pa
- refuelling loads		4 kg
- flue gas mass flow		21,6 g/s
Durability		Passed
Flue gas temperature (max.)		598,03 °C

\* Follow the safety information in the installation instructions

## 1. Contents of delivery

Please check that all parts belonging to the stove are included in the delivery (See section 5.2 picture 1.):

- 1 pc Furnace
  - 1 pc Stove hatch (glassdoor or black metal)
  - 1 pc Lower mesh of a stove (2 pc in Löyly-IKI)
  - 1 pc 45°, 90° or straight smokepipe
  - 1 pc Ash spatula
  - 1 pc Accessory box including:
    - 2 pcs “installation stones” for the furnace (on which the furnace lies)
    - 1 pcs fire plate (to be installed in the front of the furnace)
    - gloves
    - installation instructions
    - hinge for the hatch
- 

If the stove is a Plus model, the delivery also includes:

- 1 pc upper mesh for the stove
- 1 pc 75 cm or 100cm straight smokepipe

Before installation make check the following:

- Safety distances to inflammable surfaces and incombustible structures
- The connection height of a possible old chimney and installation route of a new chimney that will possibly be installed
- Floor material and weight capacity (inflammable, incombustible, tiled and waterproof)
- Note that IKI stoves have a lot of stones and are heavy (see section 3.2)
- IKI wood burning stoves are recommended to be installed primarily either in a brick chimney, ceramic chimney or an air-cooled chimney. The outer diameter of the stove’s smokepipe is 115 mm.

## 2. Installation of the stove

### 2.1 Mini-IKI, Original IKI and Maxi-IKI

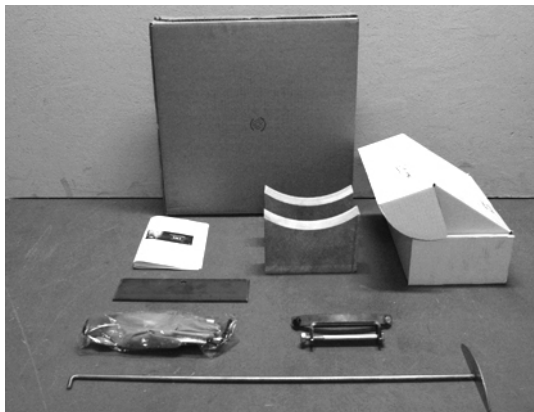

1. Check that all parts belonging to the stove are included in the delivery.

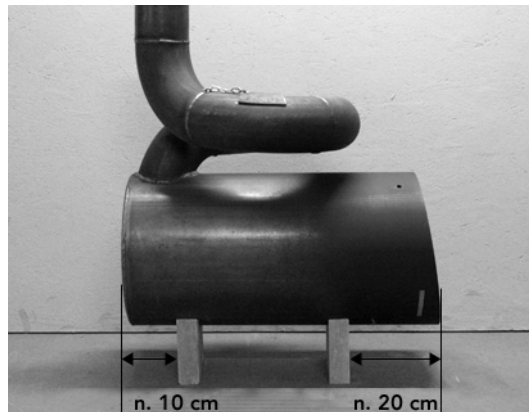

2. Set the furnace on a solid and fireproof base on two footings in the middle of the installation place of the stove.

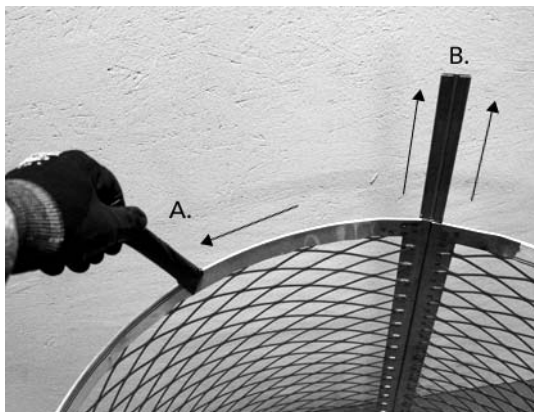

3. Remove the white protective plastic from the mesh frame parts of the stove (A.) Detach the rear metal strip from the mesh by pulling it up (B.) **TIP!** Push the mesh in on the back, at the same time as detaching and pulling the strip.

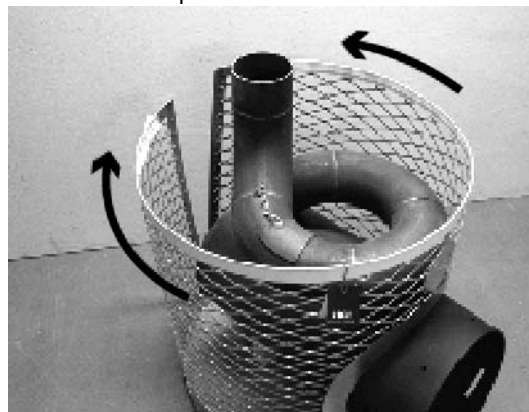

4. Set the mesh frame around the stove furnace.

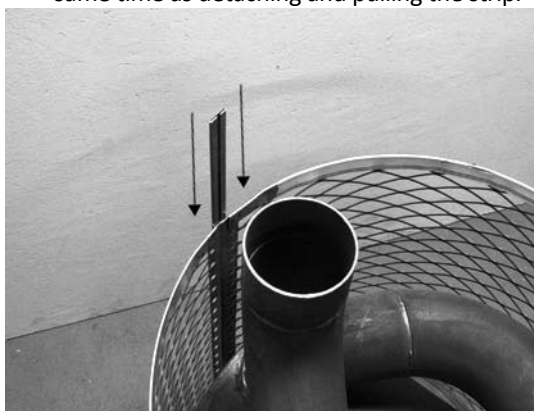

5. Attach the stainless steel rear strip by threading it back to place in the abutment. Push the mesh in again to help the strip settle in.

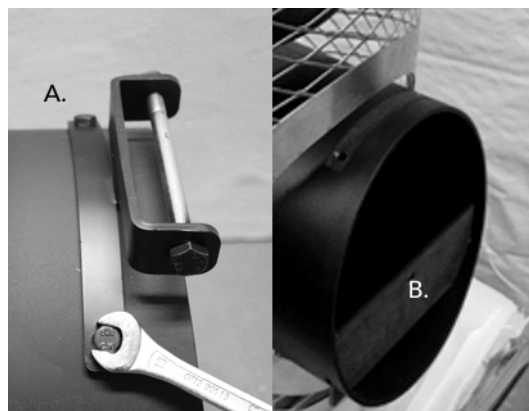

6. Attach the hinge to the furnace (A.) Install the fireplate that prevents the cinders falling to the floor (B.)





7. Install the hatch to the hinge.

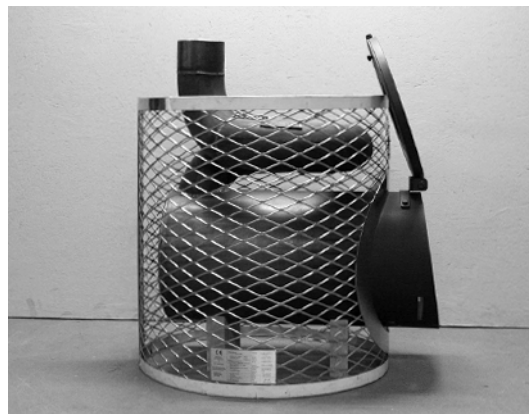

8. Check that the distance between the frame and the front part of the coil is approximately 5-7 cm, to have space for the stones. Make sure that the furnace stands horizontally. When the hatch is open, it must lean back so that it will not fall down by itself.

## Installing the mesh to Löyly-IKI:



Separate the bottom mask from the main mesh using allen key. Install the main mesh over the stove furnace. Make sure that you leave appx. 5-7cm space between furnace and the mesh.



Connect the separated bottom mask back to the main mesh. Connect the upper part of the mesh by sliding it over the main mesh. At that point make sure that the logo is lined up with the stoves furnace and hatch. Install the hatch (see pictures 6-7). Start installing the stones (see 2.2)

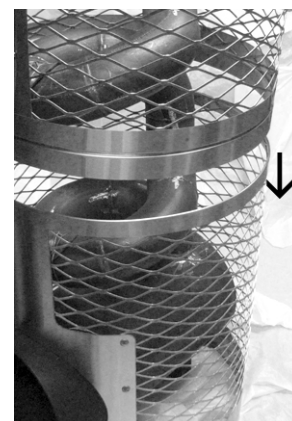

## 2.2 Setting the stones into stove:

Stones smaller than 10 cm in diameter are recommended. Ordinary stones with a rough finished surface are suitable for a stove. For example peridotite, olivine-dolerite stones. The stones should not be placed too tightly together, allowing for free air flow between the stones. Even natural stones can be loaded in the outer edges where the stones are not in touch with the heating surfaces.

Fill the space between the mesh frame and the furnace with stones carefully, one stone at a time. The first 20-30 cm from the floor are the most crucial ones while setting the stones into the heater. Then the mesh

## IKI Wood burning stoves | Installation instructions

takes its final round form. The mesh and the furnace intermediate space must be stoned as accurately as possible so that the stones will cover the furnace.

If the stove is for professional usage (public bath etc.), Ikikiuas Ltd recommends KERKES-ceramic sauna stones ([www.kerkes.fi](http://www.kerkes.fi)) on the surfaces that touch directly the heart of the stove.

**NOTE:** Stones will descent from time when heated regularly. Stones change interval depends on the quality of the stone and the stove utilization. Check the condition of the stones in normal operation each year, if necessary, remove the broken stones and replace them with new ones.

### 2.3 Plus version installation instructions

As the stove consists of a separate furnace and fire tube and two separate frames, the installation is done in phases as follows:

1. Assemble the lower part of the stove as in Mini-IKI, Original-IKI and Maxi-IKI, instructions without setting the stones yet to the top part.
2. Adjust the connection smokepipe and the upper mesh in the connection point of the chimney (picture 1.). If the connection point is deviant from the standard connection point of an IKI stove, use a suitable sidecutter to shorten/adjust the tube and mesh.
3. Pile the stones to the lower part of the stove. The mesh should lie against the circular firetube. The piling of stones in the space between the upper mesh frame and the smokepipe is done one stone at a time. When loading the stones try to cover the smokepipe as well as possible. The mesh frame settles in its place when approximately 10 cm of stones have been loaded from the surface of the furnace. It is recommended that two people do the loading of the stones of the upper mesh (pictures 2. and 3.).



## 2.4 Modifying a chimney connection to a non-standard height

The chimney connection of the plus model can be made even lower in i.e. the following

- Cut smokepipe to a desired height with i.e. with a sidecutter
- Cut the upper mesh from below and cut the straight smokepipe in proportion to match the smokepipe accordingly. Leave the “cut part” of the upper mesh to lean against the lower part of the stove

## 3. Safety distances to flammable structures

Please note that the gap between the furnace and the stone mesh must be loaded carefully with stones.

- **A.** From the stone mesh full of stones to the side 100 mm
- **B.** From the neck of the furnace to the side 250 mm
- From the glass hatch to the front 800 mm  
(Tip! Leave 1000 mm to have service space)
- From the solid hatch to the front 500mm  
(Tip! Leave 1000 mm to have service space)
- **C.** From the chimney pipe loaded with stones and equipped with a mesh to the side 250 mm
- From the chimney pipe loaded with stones and equipped with a mesh upward 500 mm
- **D.** From a chimney pipe without stones to the side 500 mm
- From a chimney pipe without stones upward 1000 mm

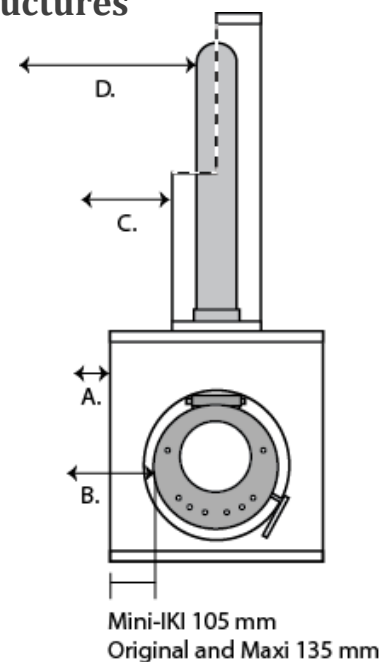

### 3.1 Reducing the safety distances

- 50 % when using simple protection (i.e. 1mm metal/fiber board and a 30mm cavity)
- 75 % when using double protection (double protection board and a cavity)

**ATTN!** The “Plus” version of the smokepipe loaded with stones reduces the safety distances 50 % compared to plain smokepipe without stones.

### 3.2 Protective base for the stove

IKI stoves also have a “IKI protective base” for the stove (IKI accessories). If that is used the stove can also be installed to the floor with flammable surface. A protective base for the stove also reduces the thermal radiation that a tiled and waterproof floor is possibly exposed to.

## 4. Connection heights

The connection height of the stoves is given from the floor to the center of the chimney when stove furnace is installed on its stone legs. **ATTN!** When using the “IKI protective base” the height of the connection point rises 70 mm accordingly.

Stove:	Connection height with 90° pipe (in pictures below)	Connection height with 45° pipe	Connection height with straight pipe
Mini-IKI	860 mm	1110 mm	-
Mini-IKI Plus	1340 mm	1620 mm	1580 mm
Original IKI	920 mm	1170 mm	-
Original IKI Plus	1430 mm	1670 mm	1650 mm
Maxi-IKI	1060 mm	1310 mm	-
Maxi-IKI Plus	1530 mm	1770 mm	1750 mm
Löyly-IKI	1220 mm	1470 mm	-

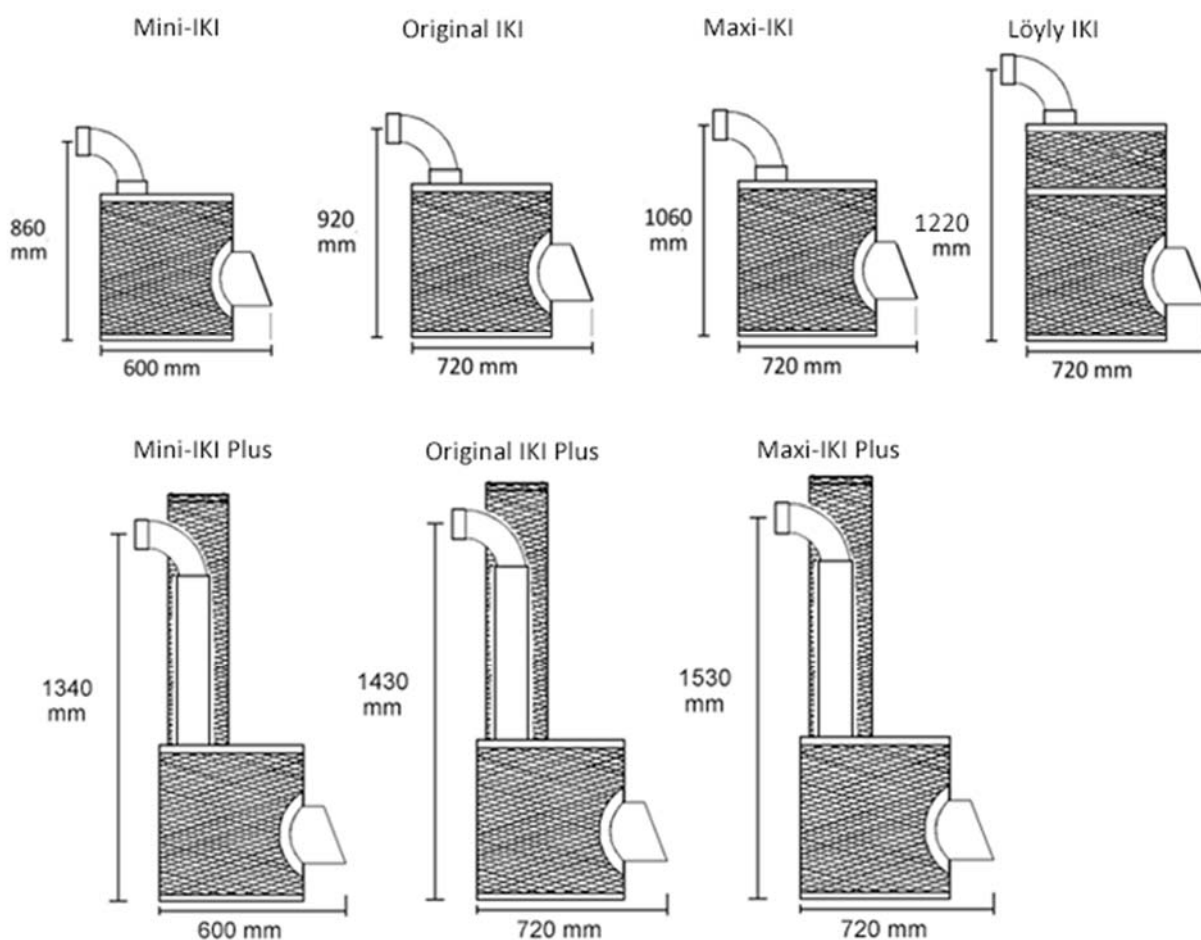

## 5. Model table

	Size of sauna	Max. amount of stones	Weight of stove (w/o stones)	Height of stove	Diameter of stove	Depth of furnace
Mini-IKI	5-12 m <sup>3</sup>	120 kg	45 kg	58 cm	48 cm	50 cm
Mini-IKI Plus	5-12 m <sup>3</sup>	180 kg	55 kg	158 cm	48 cm	50 cm
Original IKI	10-25 m <sup>3</sup>	240 kg	65 kg	65 cm	60 cm	60 cm
Original IKI Plus	10-25 m <sup>3</sup>	280 kg	75 kg	165 cm	60 cm	60 cm
Maxi-IKI	20-30 m <sup>3</sup>	300 kg	70 kg	75 cm	60 cm	60 cm
Maxi-IKI Plus	20-30 m <sup>3</sup>	340 kg	80 kg	175 cm	60 cm	60 cm
Löyly-IKI	20-40 m <sup>3</sup>	400 kg	90 kg	95 cm	60 cm	60 cm

## 6. Instructions for using the stove

The heating time of an IKI stove is approximately one hour, depending on the size of the sauna room and the stove. The correct bathing temperature for the IKI stoves is approximately 55-70 degrees.

### 6.1 Initial load and lighting the fire

- Clean the ashes from the furnace and remnants from the previous time you used the stove.
- Open the damper of the chimney and the knob on the stove hatch to get incoming compensation air to maximum amount.
- Set the wood (max. 2/3 of the height of the furnace) lengthwise in the front/middle part of the furnace, the bigger wood under and the smaller wood on top.
- Light the fire on the top of the woodpile, for example with a lighter piece, cardboard packages, birch bark or chopped firewood. Keep the draft in full open position at that moment.
- There is a knob in the stove hatch that allows you to regulate the draft. In an iron hatch the regulation is done by moving the knob up (open) and down (shut). In a round glass the regulation is done by moving the knob to the right (open) and to the left (shut).
- When adding wood to the furnace during heating, pull the ember to the front of the furnace against the fire plate and add 2-3 pieces of chopped wood on top of the ember in front/middle part of the furnace. Ikikiuas Ltd recommends that the maximum amount of firewood should be 2/3 of the space in the furnace.
- **NOTE!** The hatch of the stove may change color with time or the paint may wear out. The hatch can be repair painted using 600 degree heat resistant paint, if needed. Before painting the hatch should be polished and cleaned with a degreasant.



## 7. Troubleshooting

Description of the problem	Instructions to solve the problem
No draft is produced in the chimney Sends smoke back into the room	<ol style="list-style-type: none"> <li>1. Check the chimney (block, birds nest), check that the damper is open.</li> <li>2. Has the chimney been sooted according to the instructions?</li> <li>3. Are you in a region of low pressure? Burn some paper in the furnace first, keeping the hatch open.</li> <li>4. Check that the fire lighters are dry.</li> </ol>
The draft is too strong	<ol style="list-style-type: none"> <li>1. Regulate the draft with the hatch and, if needed</li> <li>2. If the chimney is high, regulate the damper</li> </ol>
The sauna does not heat up correctly	<ol style="list-style-type: none"> <li>1. Is the stove correctly measured with regard to the sauna room? (space, level of insulation, are there many log walls or a lot of stone surfaces)</li> <li>2. Is the ventilation correctly measured?</li> <li>3. Are there enough stones, have they been loaded correctly?</li> <li>4. Check the condition and quality of the stones (Olivine-dolerite stones, smaller than 10 cm in diameter)</li> </ol>
The stones do not heat up enough	<ol style="list-style-type: none"> <li>1. Are there enough stones, have they been loaded correctly?</li> <li>2. Check the condition and quality of the stones (Olivine-dolerite stones, smaller than 10 cm in diameter)</li> <li>3. Is the firewood dry and has it been loaded according to the instructions?</li> </ol>

## 8. The water quality for the stove

Features of the water	Effect	Recommendation
Humus content	Color, taste, precipitation	< 12 mg / l
Iron in the water	Color, smell, taste, precipitation	< 0,2 mg / l
Hardness: The main ingredients manganese (Mn) and calcium (Ca)	precipitation	Mn < 0,05 mg / l Ca < 100 mg / l
Chlorinated water	Health hazard	PROHIBITED!
Sea water / salt water	Fast corrosion	PROHIBITED!

## 9. Dimensional drawings

The outer diameter of the stove's smokepipe is 115 mm.

The distance from the center of the smokepipe to the back of the heater rim is in MINI-IKI 130 mm and in Original, Maxi-IKI and Löyly-IKI 150 mm.

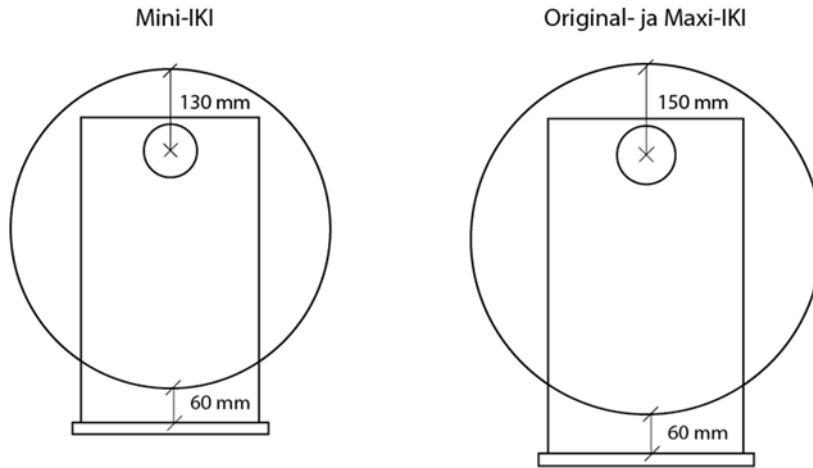

## 10. Sweeping instructions

1. Start by removing the stones from the stove.
2. Open the hatch in the chimney pipe on the stove (as seen in picture below). This does not require any tools.
3. Sweep the chimney using bendable nylon brush. DO NOT USE metal brush! It might damage the pipe from inside.
4. Other option is to use industrial vacuum cleaner to clean up the spiral.
5. Finally spray or pour some water and/or use the brush to clean up the detachable smoke pipe (**not the spiral!**)

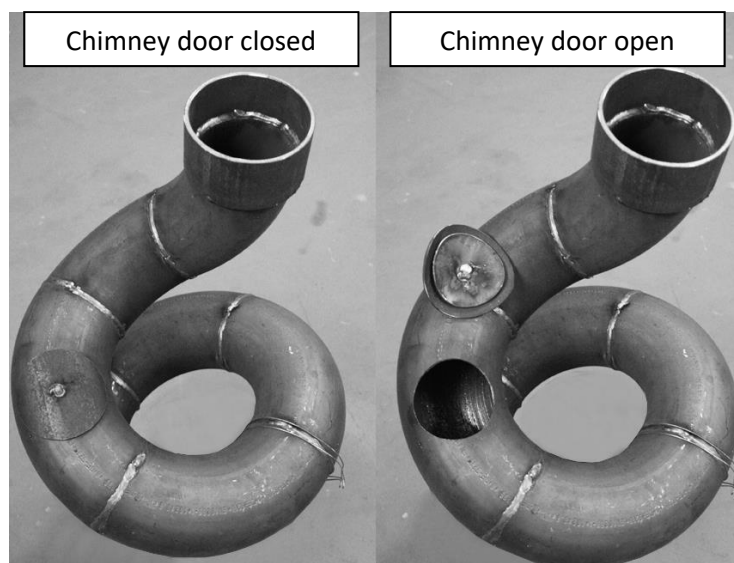

## 11. Ventilation of the sauna and getting compensation air

A wood burning stove needs sufficiently compensation air in order to burn well. A sauna room also requires oxygen-rich breathing air for the sauna bathers. Also, the drying of the sauna room after bathing requires a functional ventilation system. There are several ventilation systems provided by manufacturers, but there is probably no system that would be the only correct one. It is most important to have fire ventilation near the stove and some fresh air for the bathers to breath.

### 11.1 Tips for ventilation

Fire ventilation can work near the stove from outside, for example through a pipe equipped with a 50-100 mm grate and a disc valve beside the stove on the floor (for example a 50-100 mm pipe 50-100mm above the floor). Fresh bathing air is directed beside the stove for example with a 100 mm pipe 50-100 mm above the stone pocket of the stove.

The flow out of the sauna is preferably between the lower and upper bench through a disc valve equipped with an adjustable grid on the wall. The air valve can also be placed on the ceiling or on the wall up close to the ceiling, opposite the stove. The stove makes the air rotate inside the sauna room and the oxygen-rich compensation air moves upward and heats up in the process.

### 11.2 Automatic ventilation

In automatic ventilation the air circulation and ventilation is assisted with an IV machine, otherwise the principle is the same as in the natural ventilation.

### 11.3 Using a chimney ventilator and several furnaces in the same room

- A chimney ventilator is not recommended to be used with the woodburning sauna stoves. The temperatures of the combustion gases may break the ventilator
- If there is more than one furnace in the same room, their combustion gases must be directed to their own exhaust ducts. For example a cauldron and stove require a 2-passage chimney
- The fire ventilation and compensation air inlets must be measured as per situation (capacity for two furnaces, adjustable valve for the amount of air)



## 12. Example pictures of a correct air ventilation

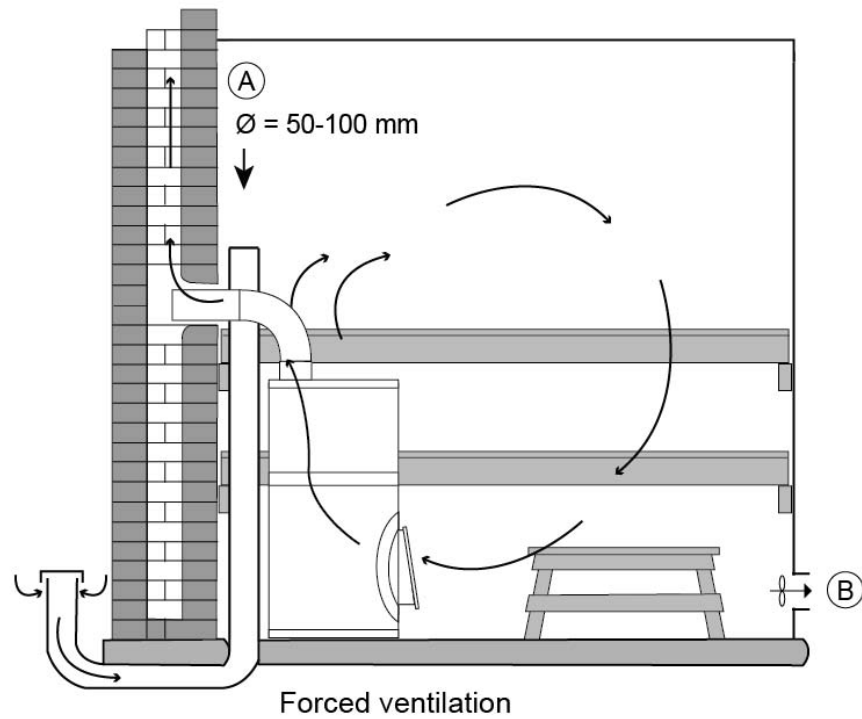
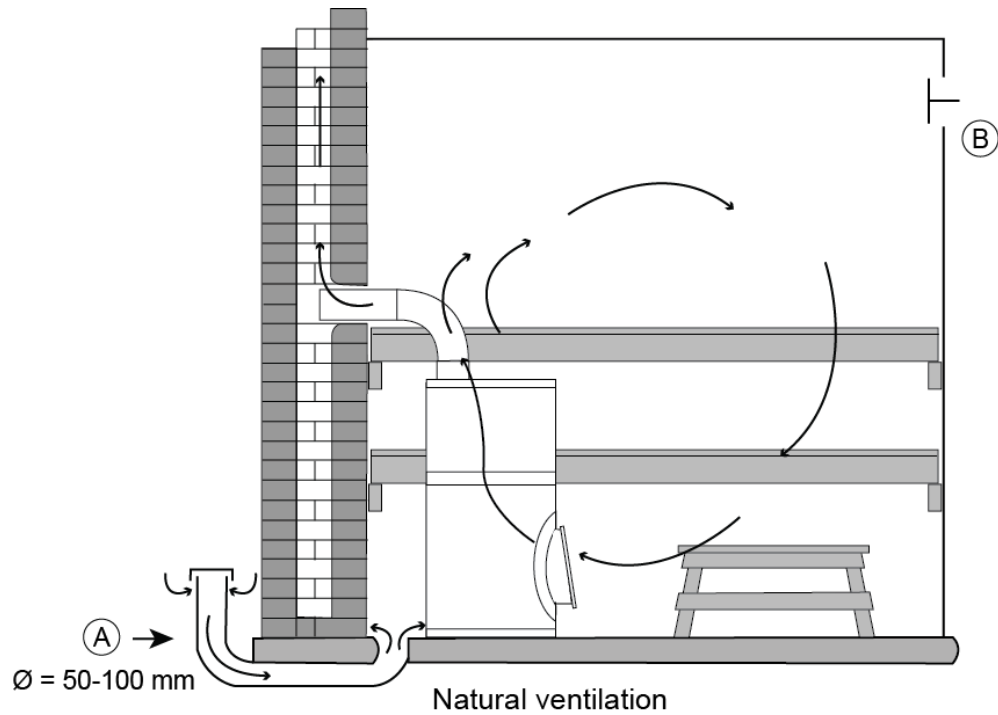

## 13. Warranty

IKI-Kiuas Ltd. grants its products a warranty according to the following conditions. The manufacturer guarantees the quality and functionality of its products for the duration of the warranty period. The warranty applies to products sold and in use within EU Region. The warranty requires that the buyer of the product follows the manufacturer's instructions regarding the placement of the heater, its installation, use and maintenance as well as those regarding the qualities of the stones used in the heater. The warranty duration is two (2) years from the date of purchase of the product. For spa-and public saunas the warranty period is one (1) year, or is determined based on the rate of usage. More information from the manufacturer.

Wood burning Warranty is subject to the following:

1. In case of defect or malfunction, the buyer must always contact the manufacturer or sales agent first before searching for the cause or attempting to repair it.
2. Stones are laid during the warranty period at least once a year and damaged stones replaced.
3. Institutional and professional use the stones have to be set again three times a year and replace them at least once a year. Proof of the operation must be presented at request. Valid guarantee of the product proof of purchase, construction works on the reception protocol, or a similar document. Ceramic heater stones are prohibited (except KERKES stones). If they are used, the warranty is not binding on the manufacturer.
4. Warranty does not cover the benches dismantling and reassembly of the stove or unloading stones and replacing.
5. **The spare part warranty** is valid for one (1) year from the date of purchase. The broken part of the corresponding replacement will be shipped free of charge to the seller or the buyer directly. The manufacturer is not responsible for the failed component removal and installation of the new part of the costs. The broken part must be sent to the manufacturer. Contact the manufacturer of your contract of carriage number before you return the part. Valid guarantee is the dealership's sales receipt, or a certificate issued by an authorized installer. The use of an authorized mechanic is required for installation of the replacement part
6. **Warranty Limitations of Liability:** The product owner must take good care of the product. On receiving the product, check that there is no transport or storage damage. In case of such damage, immediately inform the seller of the product or the shipping company. The manufacturer is not responsible for any errors, malfunctions, or defects caused by transport or by improper storage, contrary to the manufacturer's instructions for installation, operation, maintenance, or failure to product placement in a state where the circumstances do not meet the manufacturer's recommendations.
7. **Error reporting:** The buyer is the product of the error or malfunction as soon as it has occurred, and no later than within 14 days. Notification is made to the seller of the product. Warranty requirements shall be made no later than 14 days from the date of the product of the warranty period has expired.
8. Guarantee the continuation of appropriate Warranty Statement found on the basis of the manufacturer will repair or replace the defective product. Repair or replacement is done at the expense of the manufacturer. The manufacturer is entitled to a favorable option. The spare part warranty is defined in section 5 Replaced spare part is given in accordance with paragraph 5 of

---

## IKI Wood burning stoves | Installation instructions

spare parts guarantee. The original product warranty remains otherwise unchanged. The manufacturer is not liable for reimbursing any expenses, business loss or other direct or indirect harm occurred to the buyer from damages or malfunction

9. **Restoration packaging** is the responsibility of the sender. Products will be packed very carefully, so that the products are not damaged in transit. Around the product should be at least 5 cm cushion. Ikikiuas Ltd recommends that you always use the original product packaging; the manufacturer of the product is designed for the safe delivery.
10. Ikikiuas Ltd is not responsible carelessly packed refunds for damage during transportation. Coming in from the client side error costs paid by the customer. Ikikiuas Ltd reserves the right to recover the cost from the customer, if the customer returns have been subject to, or breach of the contract. Customer is charged a processing and shipping.
11. **Quality guarantee:** Ikikiuas Ltd guarantees the stainless steel components for private home usage for 10 years. During the warranty period occurring raw material or manufacturing defect resulting from the defects will be corrected free of charge. For example, throwing salt water on the heater is not allowed!

The warranty does not cover natural stone color variations characteristic, lustoisuutta and hairline cracks that do not affect safety and operations. Shipping damage must be entered in the transport document, the product is received, or within 7 days of arrival of goods to the recipient. Transport damage must also be reported to the shipping company's last contact. The damaged part must be kept for inspection. The delivery company insurance compensates for the new one.

**IKI**

---

KIUKAISTA KIUKAIN