

# Wellness objects

Things to know and technology

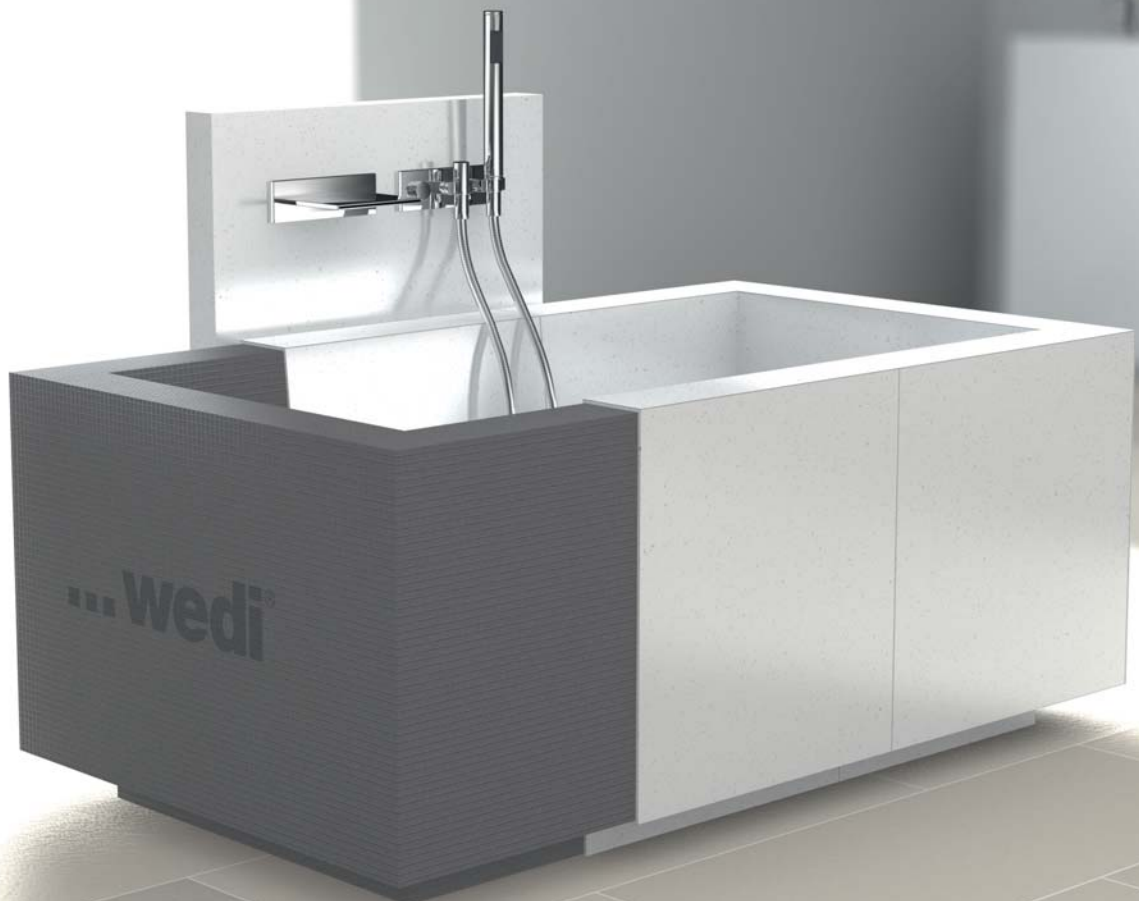



wedi products and systems are of a high standard of quality and have received numerous certifications throughout Europe.

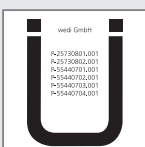

# Contents

## Fundo design showers

---

- Page 4 Building of shower wall Fundo Trollo / Nautilo
- 6 Building of shower wall Fundo Trollo <sup>libero</sup> / Nautilo <sup>libero</sup>

## Sanoasa Wellness Multicenter

---

- Page 10 Technical data
- 12 Wellness Multicenter

## Sanoasa Vario cubicles

---

- Page 16 Technical data
- 17 Vario cubicles

## Sanoasa Wellness Benches

---

- Page 18 Technical data
- 19 Wellness Benches

## Sanoasa Wellness Loungers

---

- Page 20 Technical data
- 22 Wellness Loungers

## Sanbath bathroom furniture

---

- Page 24 Technical data
- 26 Bathtub
- 28 Washbasin
- 29 Shower column

## Special applications

---

- Page 30 Glass door with stainless steel frame

# Building of shower wall Fundo *Trollo / Nautilo*

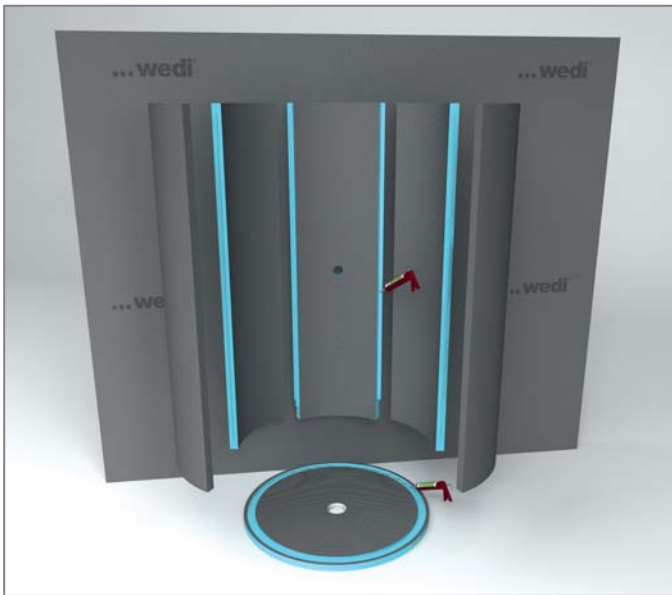

wedi Fundo design showers consist of a floor element and the appropriate separation walls. They are manufactured from the wedi building board base material and are equipped with a fitted and sealed floor drain (vertical or horizontal), a supplementary waterproof coating and a predefined slope. The installation instructions are stated below, taking Fundo Trollo as an example.

**wedi system components:**

- wedi Fundo *Trollo / Nautilo*
- wedi *Tools* self-adhesive reinforcement tape
- wedi 610 adhesive sealant



1 When installing the floor element, care must be taken in order to ensure that it is mounted adjacent to the wall.

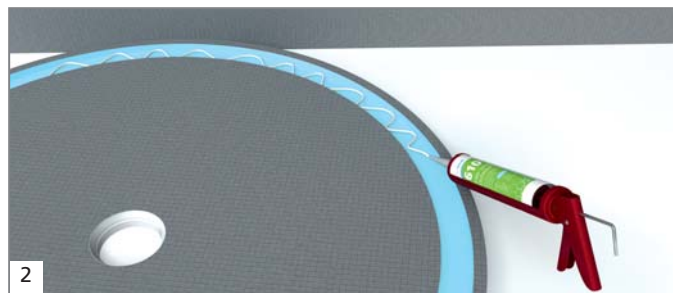

2 Apply wedi 610 adhesive sealant in waves onto the cut-out; then, place the individual wall elements into this cut-out.

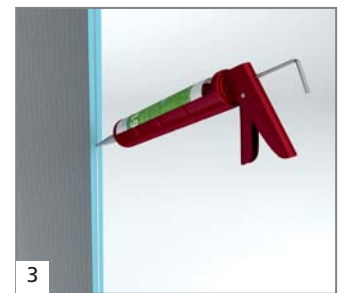

3 The wall elements are connected by a tongue and groove process using wedi 610 adhesive sealant, which is applied to the groove and on the left and right sides of the tongue.

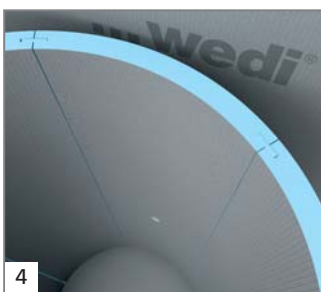

4 Then, the wall elements are installed one after the other in accordance with the installation instructions.



5 Apply wedi *Tools* reinforcement tape to the inside and outside of the joints.

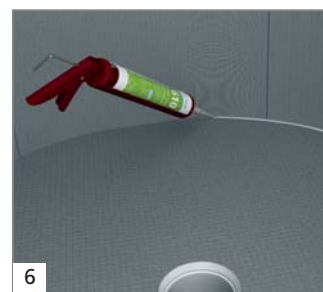

6 Seal the transition of the shower walls to the inside of the floor board by using wedi 610 adhesive sealant.

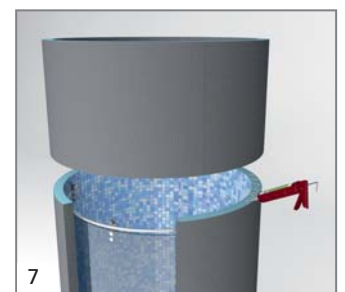

7 Optional height increase by using the extension element is possible. Apply wedi 610 adhesive sealant and wedi *Tools* reinforcement tape.

## Continuation of installation steps

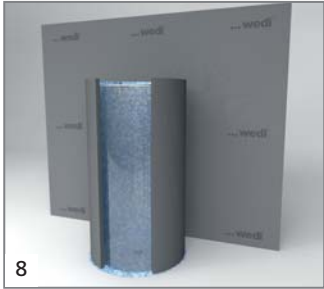

Due to the absence of any installation ducts, siting of the unit should always be made with a load bearing wall behind to support any fixtures or fittings made.

Then, tile as normal and install any desired fittings and shower rod, through the board into the load bearing wall behind.

## Installation of glass sliding door

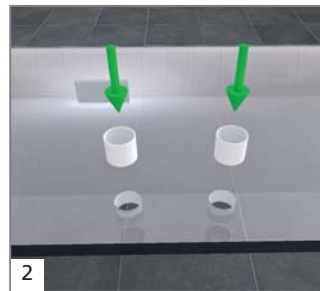
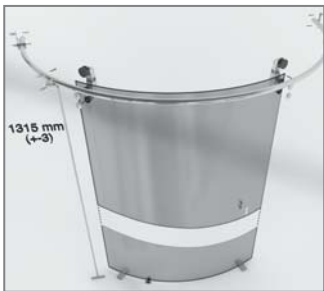

The glass sliding door is only available for the two shower versions wedi Fundo Trollo and wedi Fundo Trollo *libero*.

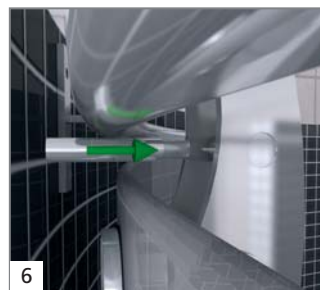
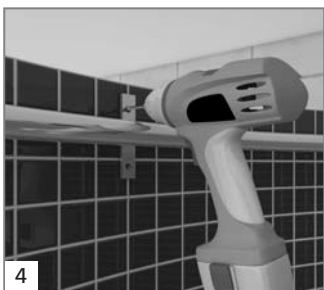

# Building of shower wall Fundo *Trollo libero* / *Nautilo libero*

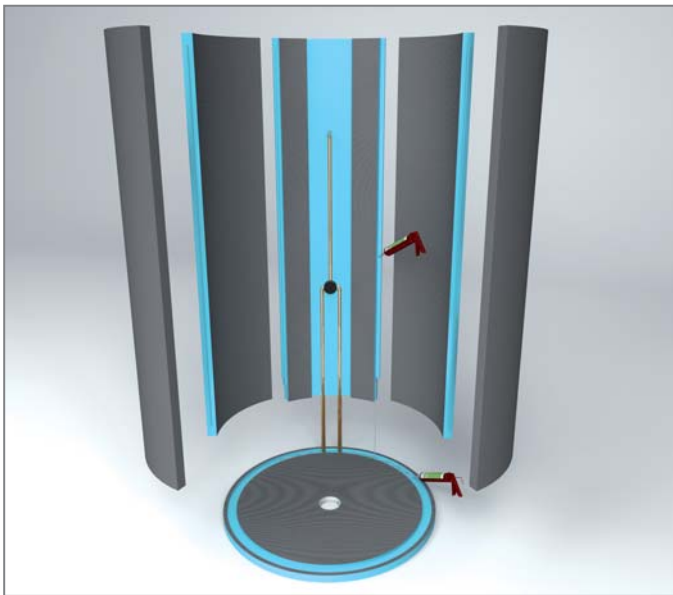

wedi Fundo design showers consist of a floor element and the appropriate separation walls. They are manufactured from the wedi building board base material and are equipped with a fitted and sealed floor drain (vertical or horizontal), a supplementary waterproof coating and a predefined slope. The version Fundo Trollo "libero" differs from Fundo Trollo by the reinforced back element for attachment of fittings and shower attachments. This also allows for isolated placement. The installation instructions are stated below, taking Fundo Trollo libero as an example.

**wedi system components:**

- wedi Fundo *Trollo libero* / *Nautilo libero*
- wedi *Tools* self-adhesive reinforcement tape
- wedi 610 adhesive sealant

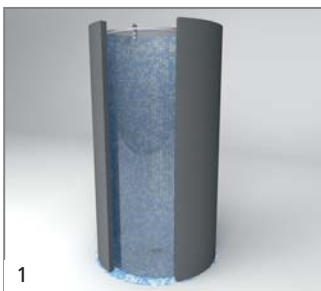

1  
Due to the integrated installation ducts, siting of the unit can be made anywhere within the room.

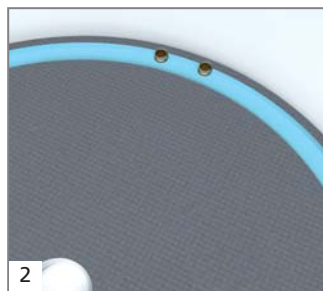

2  
When installing the floor elements, the cold and hot water inlet pipes should be allocated as per the installation plan.

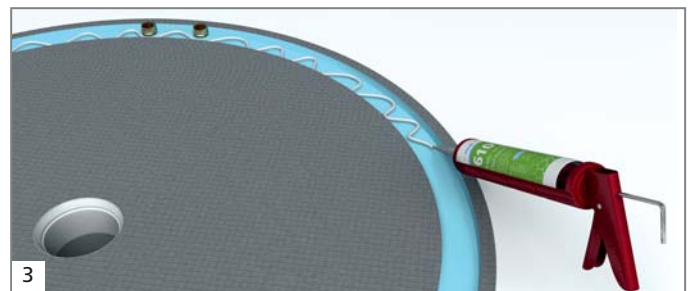

3  
Apply wedi 610 adhesive sealant in waves onto the cut-out; then, place the individual wall elements into this cut-out.

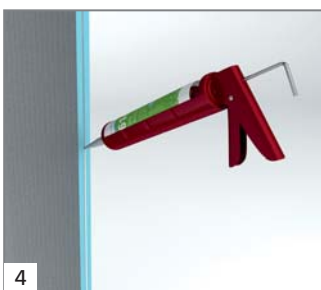

4  
The wall elements are connected by a tongue and groove process using wedi 610 adhesive sealant, which is applied to the groove and on the left and right sides of the tongue.

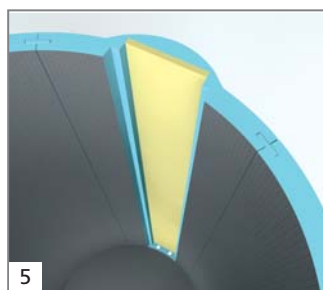

5  
Then, the wall elements are installed one after the other in accordance with the installation instructions.

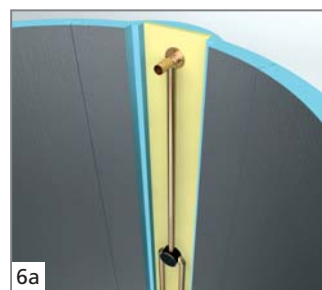

6a  
Flush-mounted fittings: fasten and connect inlet pipes behind the posterior reinforcement board by using drywall screws.

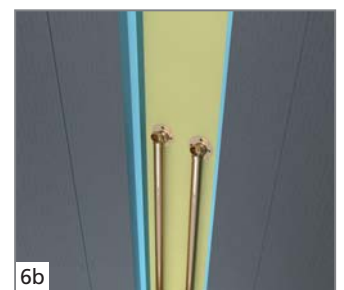

6b  
Surface-mount fittings: fasten wall boards to the posterior reinforcement board, and install suitable tap extension, if required.

## Continuation of installation steps

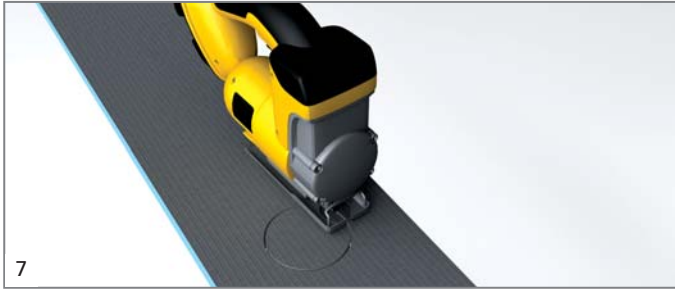

7  
Cut holes for fittings in the cover panel and glue into place.

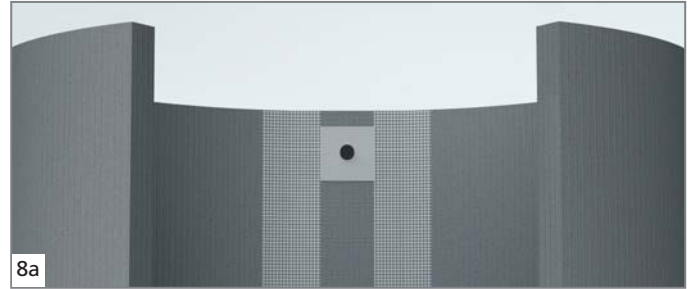

8a  
Version Fundo Trollo <sup>libero</sup>, flush-mounted fittings:  
Seal holes with wedi 610 adhesive sealant and suitable wedi Tools sealing collars.

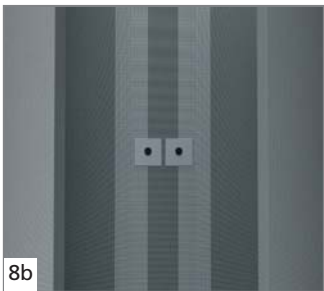

8b  
Surface-mount fittings:  
Seal as with inlet pipe cut-outs.



9  
Apply wedi Tools reinforcement tape to the inside and outside of the joints.

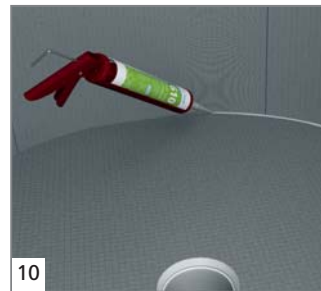

10  
Seal the transition of the shower walls to the inside of the floor board by using wedi 610 adhesive sealant.

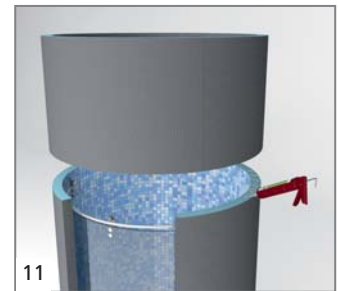

11  
Optional height increase by using the extension element is possible. Apply wedi 610 adhesive sealant and wedi Tools reinforcement tape.



12  
Then, tile as normal and install any desired fittings and shower rod at the reinforced wall element, if applicable.

Technical drawing

Fundo Trollo, floor element

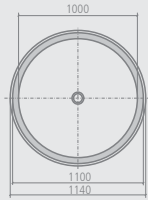

Fundo Trollo, wall element

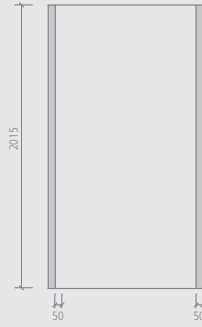

Fundo Trollo, attachment element

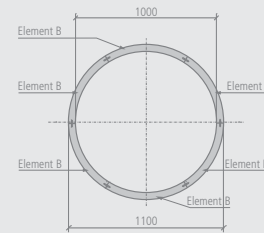
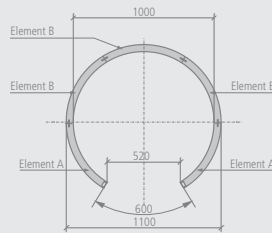
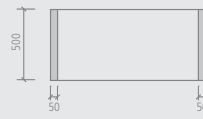

Fundo Nautilo, entry right

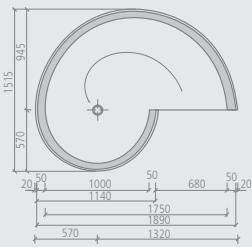

Fundo Nautilo, wall element

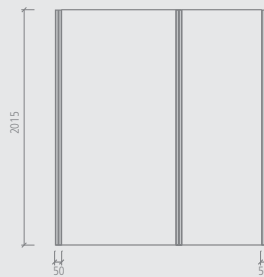

Fundo Nautilo, attachment element

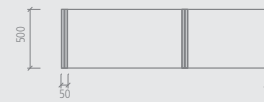

Fundo Nautilo, entry left

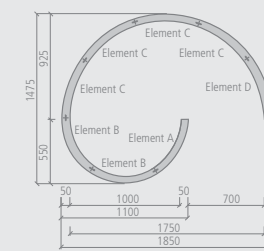
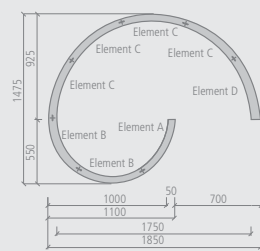
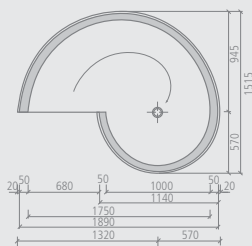



Technical drawing

Fundo Trollo, floor element

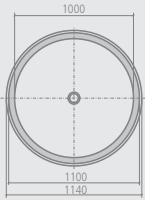

Fundo Trollo *libero*, design shower

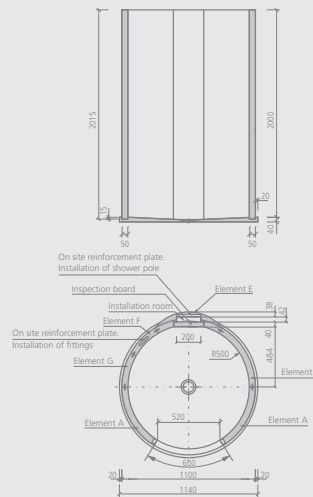

Fundo Trollo *libero*, attachment element

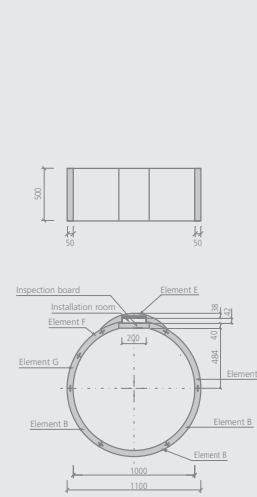

Fundo Nautilo, entry right

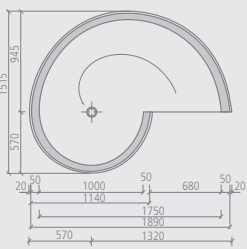

Fundo Nautilo *libero*, design shower

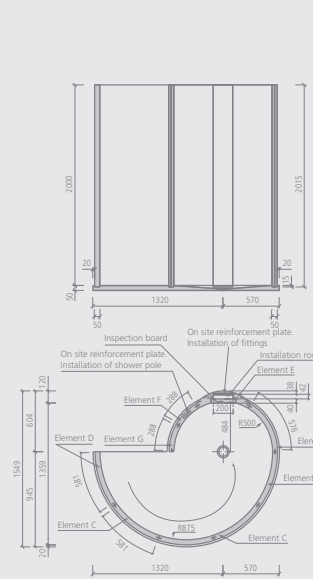

Fundo Nautilo *libero*, attachment element

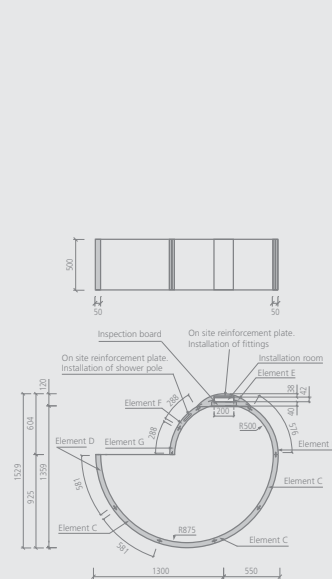

Fundo Nautilo, entry left

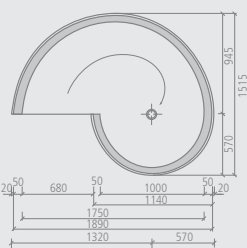

# Sanoasa Wellness Multicenter



	Sanoasa Libertà	Sanoasa Esotica	Sanoasa Agola	Sanoasa Porta
<b>Fundo</b>				
- board	•	•	•	•
- drain	•	•	•	•
<b>Wall elements</b>				
- vapour technology	•	•	•	•
- shower technology	•	•	•	•
<b>Massage nozzles</b>				
- 4 pieces	•	•	•	•
- 6 pieces	optional	optional	optional	optional
<b>Fittings</b>				
- hansgrohe set of fittings	•	•	•	•
<b>Seats</b>				
- 2 benches, teakwood	•	–	–	–
- 1 bench	–	•	–	–
- 1 bench, semi-circular	–	–	–	•
- 2 stools	–	–	•	–
<b>Glass modules</b>				
- door 1.0 m	•	•	–	•
- wall 1.0 m	2 pieces	–	–	•
- wall 0.6 m	–	•	–	–
- door, 5-sided	–	–	•	–
<b>Lighting</b>				
- halogen spotlight, 2 pieces	•	•	•	•
- LED spotlight, 2 pieces	–	–	optional	–
- LED spotlight, 4 pieces	optional	optional	–	optional
- fibreglass cable	optional	optional	optional	optional
<b>Music</b>				
- Speaker, 2 pieces	•	–	–	•
- Speaker, 1 piece	–	•	•	–

## Requirements to be granted by the customer

### Notes

- The wedi Sanoasa Multicenters are ready-to-use vapour showers (number 7 – 10) for domestic use. They are not suitable for use with commercial systems.
- The complete vaporiser technology, lighting technology and shower technology is factory-made and integrated.
- The prepared piping for shower and vapour panel are connected to the cold and hot water inlet pipes by the customer.
- Power supply is connected centrally to the junction box. The lighting technology located in the roof is connected to the prefabricated transformers by using plug connectors.

### Technical requirements

#### Water connection

- Hot/cold water connection
- Inlet: 3/4 inch female thread
- Minimum pressure: 3 bar

#### Electric connection

- Supply line 400–415 V 3/N/PE 6.6 kW 3X 16 A
- Supply line 230 V 1/N/PE 10 A

## General technical data

### Floor drain

- Drain capacity as per DIN EN 1253 0.8 l/sec.

### Vaporiser

- Steam generator, type Steam 6 VB
- 6.6 KW, 400 V 3 x 16 A  
(optional 230 V connection)
- Only for domestic use (no commercial use)

### Control device

- Manual on/off
- Setting of bath temperature
- Setting for automatic switching-on (pre-select time)
- Coded access for protection of all settings
- Switch for lighting

### Electric installation

- Electronic cabling of vaporiser technology and lighting technology is completely pre-installed at the factory.
- The main supply should be connected to the two central junction boxes; this should be performed on site by a qualified electrician.
- Voltage supply of the feed line should not be interrupted. That is why switches and similar devices must not be used with the feed line.

### Water installation

- Before installation of the wedi Sanoasa Multicenter vapour shower, the hot and cold water lines should be installed in the connection box (see installation plan for hot and cold water).
- The water-conducting lines should be rinsed before connection. Rinsing prevents intrusion of chips and other contaminants into the steam generator system.

- The whole water-conducting system should be subject to a pressure test before tiling and before commissioning.
- Installation should be performed by a professional sanitary engineer.

### Steam generator

- The installed steam generator is equipped with a stainless steel water tank as well as acid-resistant and rustproof pipe elements.
- Emptying of the steam generator (automatic fourfold rinsing) is automatically performed one hour after turning off the steam generator.



#### Important information:

Hot vapour escapes from the vapour nozzle. The vapour has a temperature of more than 100°C. Never leave young children alone in the cubicle. Do not touch or come close to the vapour outlet during operation of the steam generator.

- The steam generator is equipped with an electronic control of water filling level, electronic level protection, non-scale self-cleaning electrodes, safety valve, temperature protection, dirt filter (splash-proof version).

### Steam generator

- The steam generator is equipped with temperature protection and switches off at a water tank temperature of 107°C.
- Steam generator does not work with osmosis plants.

# Sanoasa Wellness Multicenter

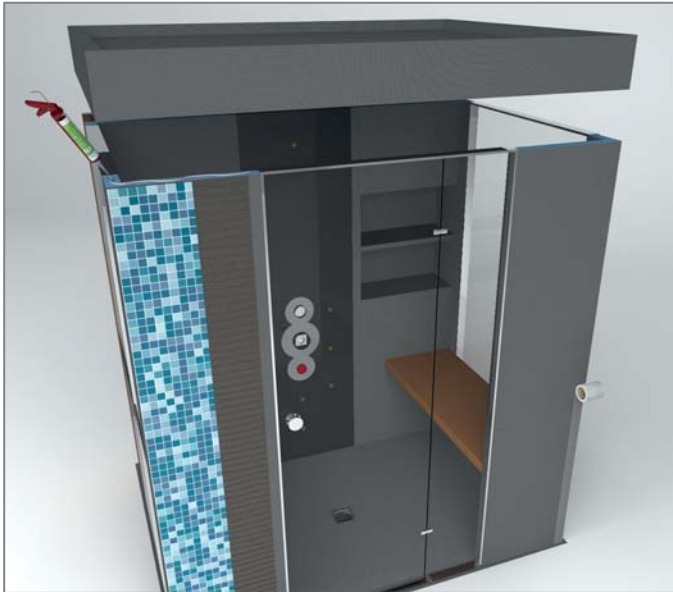

The wedi Sanoasa Multicenters offer almost everything converting a normal shower into a wellness centre. Massage showers with lateral side body jets, purifying vapour steam applications beneficial for the cardiovascular system, or relaxing lighting with adjustable colours as well as various designs that can be individually adapted to the room concept are all included in the system. These Multicenters can also be equipped with a multitude of optional features such as exclusive shower panels, a Raindance shower, additional LED technology, fibreglass lighting with 50 spots, or vapour nozzles made of high-quality stainless steel.

 **wedi system components:**

- Sanoasa Wellness Multicenter
- wedi 610 adhesive sealant
- wedi *Tools* self-adhesive reinforcement tape

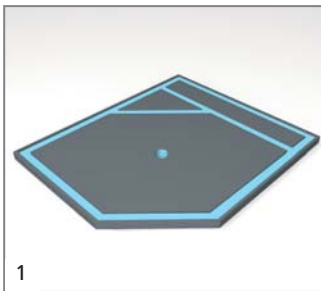

1  
Before installing the wedi Fundo base unit, the cold and hot water inlet as well as power supply should be connected in accordance with the installation plan.

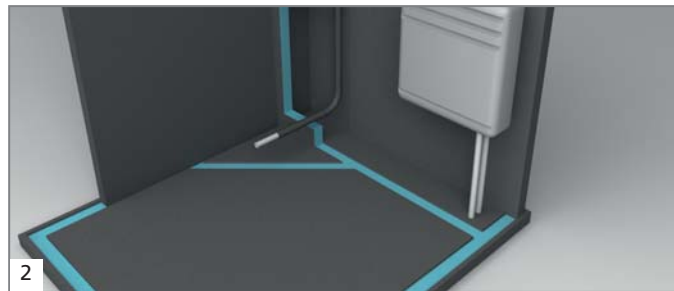

2  
First, the wall with the steam generator is glued into the grooves of the floor board by using wedi 610. Water supply lines, drainage and steam pipes can either be connected and sealed at the factory, or prepared for the fitter on site.

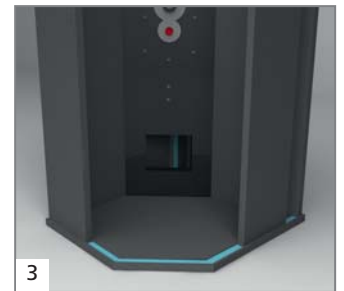

3  
The shower panel wall is bonded to the groove in the Fundo base unit and to the wall boards either side. Water connections, steam pipes and drainage should be connected and pressure-tested by the fitter before tiling.



4  
The cubicle is checked for correct vertical position and alignment before curing of the sealant. The dimensions of the glass elements to be installed must be double-checked because later changes will require increased efforts.

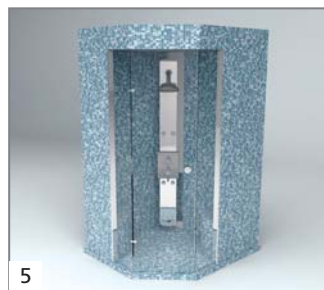

5  
Now, the whole cubicle can be tiled and grouted, finishing with the installation of the glass elements.



## Installation of glass pane

Basics

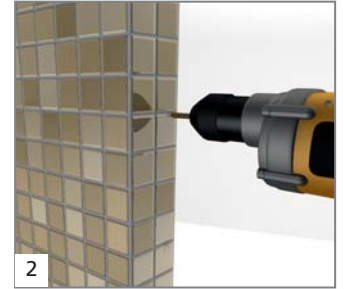

The fixed glass elements should be installed so that the glass panes can be introduced from outside. The glass used is 8 mm toughened safety glass.

The installation L-profile is held to the tiled and grouted inner edge of the cubicle so that the glass pane can be slid flush alongside the wall and ceiling profile and the drill holes can be drawn onto the ceramics. This process is performed on both sides of the glass pane. If the installation L-profile is too long due to very thick floor tiles, this profile can be shortened by the customer.

The ceramics are drilled at the drill hole markings. There is a metal profile behind the ceramics that must not be drilled. Only the ceramics must be drilled.



Attention: the self-tapping screws can only penetrate the metal, not the ceramics. Do not overtighten the self-tapping bone screws. Important: this process is performed on both sides of the glass pane.

In the first step, the glass pane is inserted into the roof groove and then slid sideways into the L-profile. In the floor area, the enclosed glass spacers are placed onto the tiles, and the glass pane is lowered.

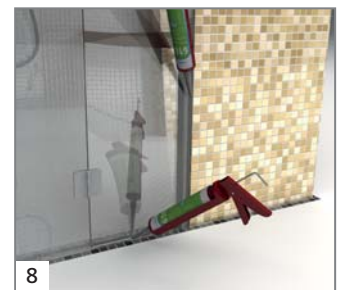

Then, the glass pane is bolted to the L-profile by using the enclosed fixing elements.

Each profile should be fixed with 5 fixing elements.

The cover profile is clipped over the fixing elements. If the cover profile is too long due to very thick floor tiles, this profile can be shortened by the customer.

The glass element should be finished/sealed with silicone at the following transition points:

- Glass pane to ceiling
- Glass pane to floor tile
- Cover profile to tiles

## Installation of glass door

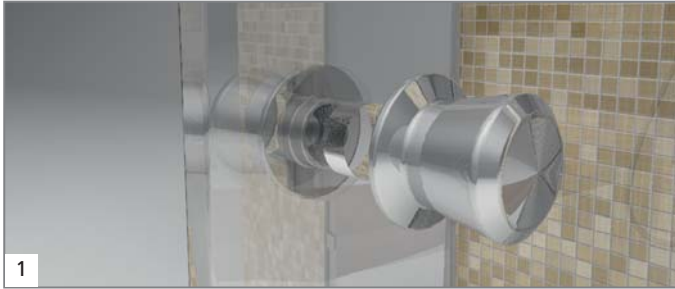

1  
Before installation of the glass door, install the fixed glass element as stated in steps 1 – 6 of the glass pane. Installation of the glass door should be performed by two persons. One person holds the glass door – the other person fixes in place. For purposes of improved handling it is recommended to fix the door knob in place first.



2  
In the first step, the hinges are screw-connected to the fixed glass element. Then, the glass door is screw-connected to the fixed glass element.

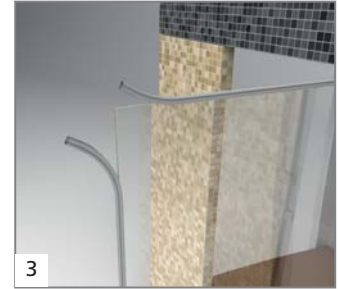

3  
The rubber door seals are inserted onto the glass door.



4  
The door stop profile is centrally held to the inner edge of the cubicle on the opposite side of the fixed glass pane so that the drillholes can be drawn onto the ceramics.

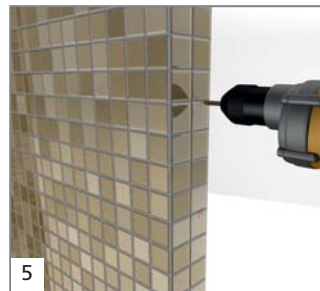

5  
The ceramics are drilled at the drillhole markings. There is a metal profile behind the ceramics that must not be drilled.



6  
The door stop profile is centrally fixed on the edge by using self-tapping screws. Attention: do not overtighten the self-tapping screws.

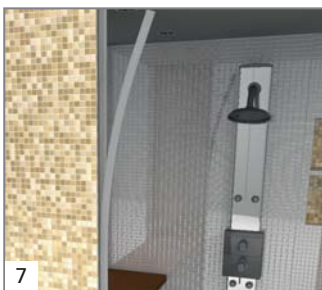

7  
The tapered door seal is plugged onto the door stop profile.

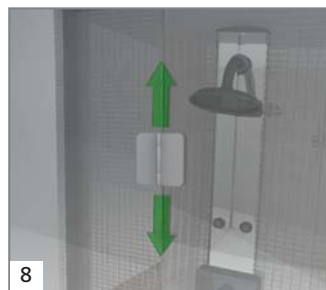

8  
The door should be aligned; this can be done by using the hinges. In the case of high deviations, it will be possible to loosen the fixing elements and to align the fixed glass element and the door.

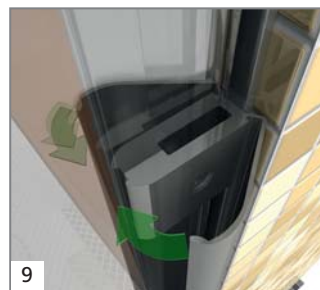

9  
The cover profile is clipped onto the fixing elements. If the cover profile is too long due to very thick floor tiles, this profile can be shortened by the customer.

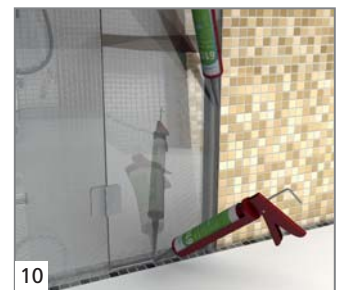

10  
The glass element should be finished/sealed with silicone at the following transition points:

- Glass pane to ceiling
- Glass pane to floor tile
- Cover profile to tiles

## Sanoasa Vario cubicles – overview



	Sanoasa Toretta	Sanoasa Pergola	Sanoasa Capricia	Sanoasa Bicocca	Sanoasa Vista	Sanoasa Panorama
<b>Fundo</b>						
- board	•	•	•	•	•	•
- drain	•	•	•	•	•	•
<b>Wall elements</b>						
- vapour technology	–	–	–	–	–	–
- shower technology	–	–	–	•	–	–
<b>Massage nozzles</b>						
- 4 pieces	–	–	–	•	–	–
- 6 pieces	–	–	–	–	–	–
<b>Seats</b>						
- 1 bench	•	–	–	–	•	•
- 2 benches	–	•	•	•	–	–
<b>Glass modules</b>						
- door 0.63 m	•	•	•	•	–	–
- door 0.9 m	–	–	–	–	•	•
- wall 0.82 m	–	–	–	–	–	•
<b>Heating</b>						
- wall heating	optional	optional	optional	optional	optional	optional
- bench heating	optional	optional	optional	optional	optional	optional



## Sanoasa *Toretta* | Vario cubicle

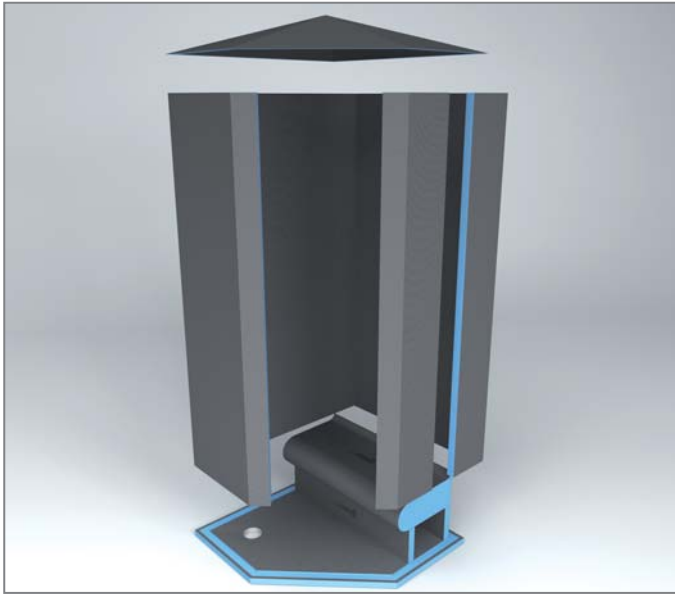

wedi Vario cubicles are special steam shower cubicles that can be individually integrated in any type of bathroom thanks to their various shapes, sizes and possible configurations. Corner or wall positions, with or without roof installations – these cubicles are intentionally designed without lines or vapour and shower technology; thus they can be easily integrated and connected into any room and adapted to the desires of the user.

### wedi system components:

- Sanoasa *Toretta* Vario cubicle
- wedi 610 adhesive sealant
- wedi *Tools* self-adhesive reinforcement tape

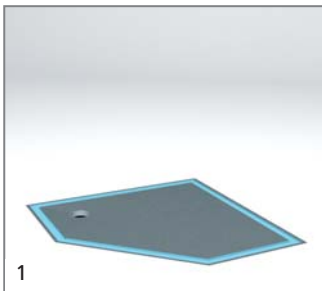

1  
Installation of wedi floor element.

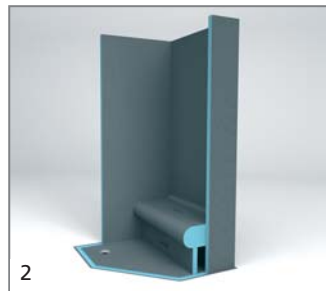

2  
Install wellness bench.

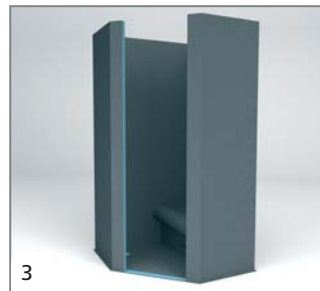

3  
Install individual wall elements on after the other.

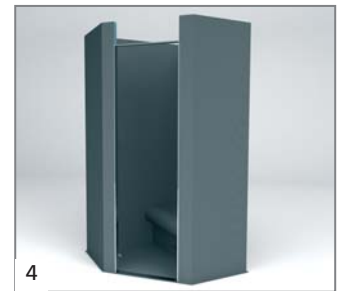

4  
Install supplied Eterna door frame.



5  
Installation of roof. Then, install glass door.



6  
Finally, tile or apply plaster and paint to the outer area.

## Bench elements



Sanoasa *Foruua*  
Wellness bench



Sanoasa *Foruua linea*  
Wellness bench



Sanoasa *Collina*  
Wellness bench



Sanoasa *Collina linea*  
Wellness bench

## Modular bench elements



Sanoasa *Cowoda*  
Wellness bench

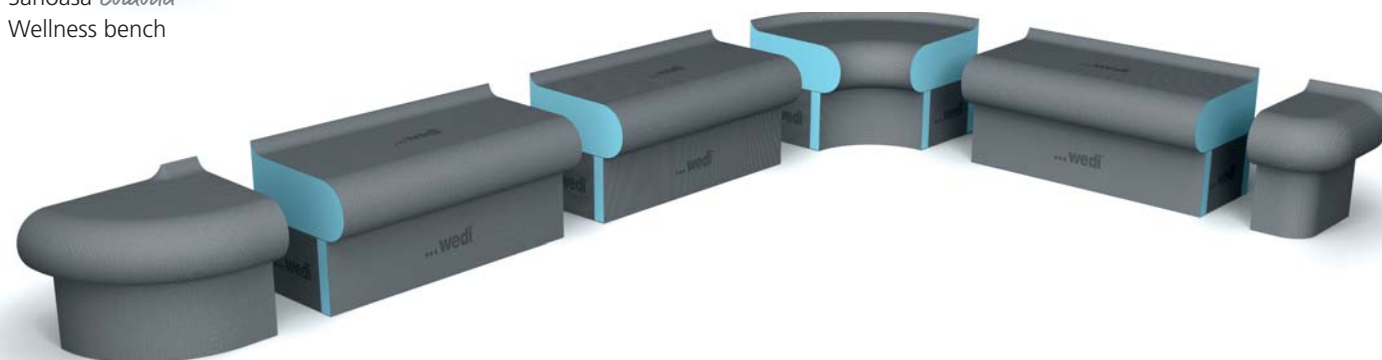

Sanoasa *Bellina*  
Wellness bench

# Sanoasa *Collina*<sup>linea</sup> | Bench element



Sanoasa benches are available in a multitude of designs so that almost any combination of seats can be created. Straight benches, corner benches or smooth finishes – your bathrooms and wellness facilities will get an individual appearance. The following instructions use the Sanoasa Collina bench elements as an example.

### wedi system components:

- Sanoasa *Collina*<sup>linea</sup> wellness bench
- wedi 610 adhesive sealant
- wedi *Tools* self-adhesive reinforcement tape
- wedi sealing tape

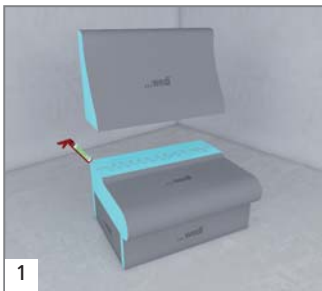

1  
When using multi-part bench elements, these should be assembled before placement of the individual benches.



2  
When using benches without corner elements, these should be mitred.

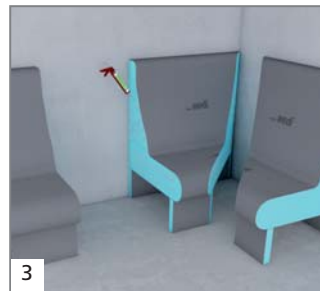

3  
Connect the bench elements by using wedi 610 adhesive sealant ...

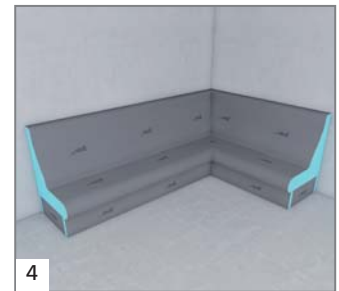

4  
... to create the desired bench shape and size.



5  
Apply wedi *Tools* reinforcement tape to all joints of the bench elements.

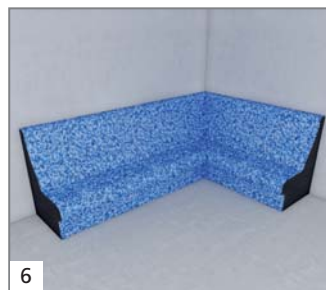

6  
Then, the bench elements can be individually tiled.

### Important information:

Hot-water heating should be connected to the separately regulated heating circuit.

# wedi Sanoasa *loungers 1 – 5*

## General product description

The Sanoasa Wellness loungers stand out due to their original and unique shapes. They give an individual touch to every wellness area. The number of possible shapes is almost unlimited so that they can be integrated into a harmonised room concept. Sanoasa lounge 1 is available tiled with classic mosaic. Loungers 1 – 5 of this design series are available with optional integrated hot-water or electric heating for the ultimate relaxation experience.

## Applications

### Sanoasa *loungers 1 & 5*:

- Lounger that can be tiled, supplied as one unit. Bonding of lounge on the floor can be achieved using universal tile adhesive or wedi 610 adhesive sealant.

### Sanoasa *lounger 2, 3 & 4*:

- Lounger that can be tiled, consisting of a lounge and carrier element. Bonding of elements and on the floor can be achieved using wedi 610 adhesive sealant.

## Technical data – heating

### Lounger including hot-water heating:

- The lounge consists of a 12 x 2 mm composite pipe completely made of plastic that has been integrated into the lounge at the factory. This pipe should be connected to the heating system on site by a qualified heating specialist.

### Lounger including electric resistor heating:

- Single conductor heating cable, approx. 150 W/m<sup>2</sup>, 2-sided connection, supply voltage 1/n/PE ~ 230 V 50 Hz, protection category IP X8 (must only be connected by qualified electricians); avoid trapped heat.





# Sanoasa Wellness Loungers

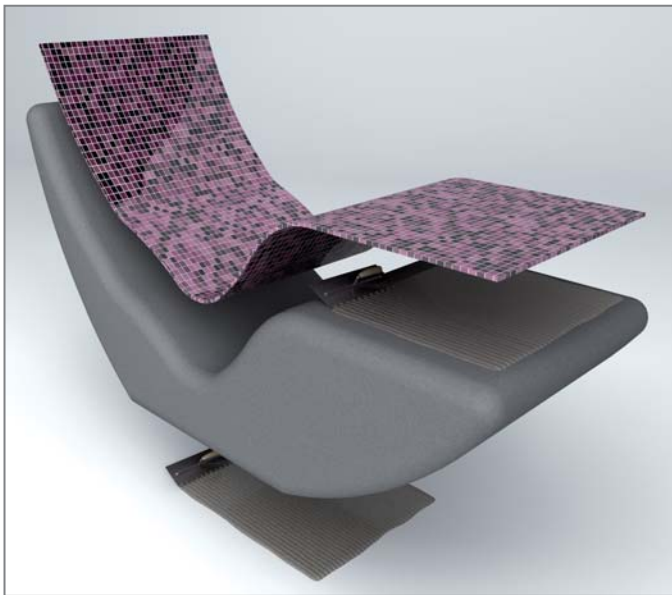

The Sanoasa loungers stand out due to their original and unique shapes. They set individual accents in wellness areas in a variety of styles and designs and can be harmoniously integrated into the total room concept. Upon request, all loungers are available with integrated heating (hot-water or electric heating). All loungers with electric heating offer two thermostat options: AEG 900 (flush-mount thermostat) and AEG 300 (rail-mount thermostat).

 **wedi system components:**

- Sanoasa Wellness Loungers
- wedi 610 adhesive sealant
- wedi *Tools* self-adhesive reinforcement tape



1 Apply a contact layer of tile adhesive onto the full floor area of the lounge, and then apply adhesive (alternative: wedi 610 adhesive sealant).

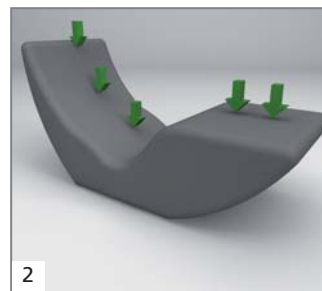

2 Place lounge into correct position and press it into the adhesive.



3 Apply wedi Tools reinforcement tape at the lounge's transition areas to the substructure; apply tile adhesive.

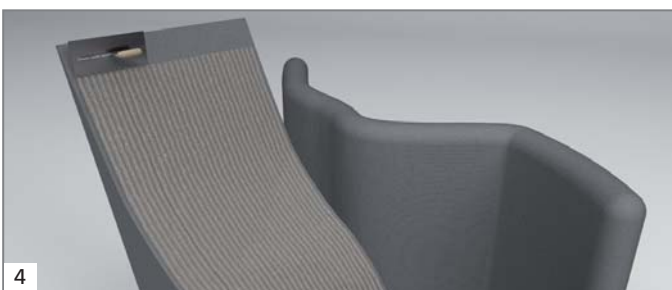

4 Perform bonding of lounge to the floor areas similar to bonding of one-part loungers (see 1). Then, glue the lie-down surface to the substructure using tile adhesive (alternative: wedi 610 adhesive sealant). For this, apply the adhesive as a contact layer first covering the full area; then, distribute the adhesive all over the surface.

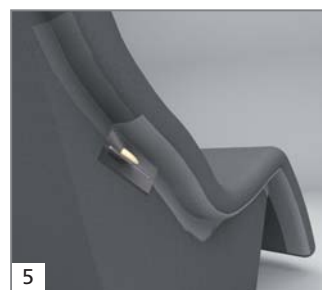

5 Then, reinforce the transitions between substructure and lie-down surface by using tile adhesive and wedi Tools reinforcement tape.

## Special features of Sanoasa Wellness Lounger no. 4: different surfaces

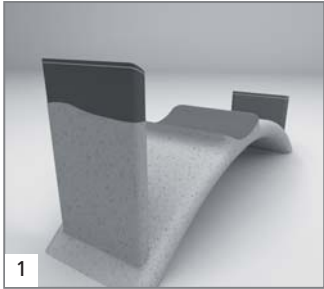

1 Apply plaster, tiles or similar to the substructure up to the marking.



2 Apply tile adhesive or wedi 610 adhesive sealant to the bonding surface.

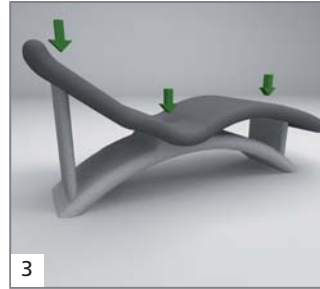

3 Press lie-down surface into the adhesive.



4 Apply tiles to lie-down surface and connect it to the substructure.

## Special features of Sanoasa Wellness Lounger no. 4: uniform surfaces

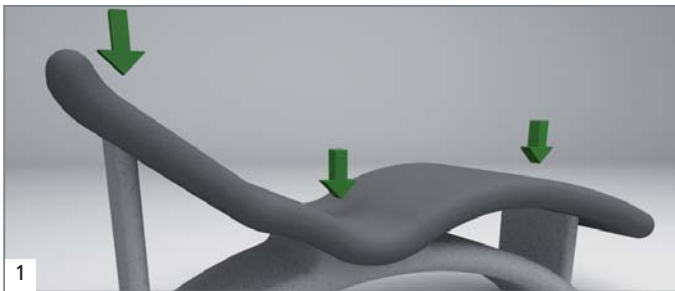

1 Bond lie-down surfaces and substructure by using tile adhesive or wedi 610 adhesive sealant as an alternative.



2 Press lie-down surface into the adhesive.

## Lounger including hot-water heating

The lounger consists of a 12 x 2 mm composite pipe completely made of plastics that has been integrated into the lounger at the factory. This pipe should be connected to the heating system on site by a qualified heating specialist.

## Lounger including electric heating

Heating cable	single conductor heating cable
Specific output	approx. 150 W/m <sup>2</sup>
Connection	2-sided connection
Supply voltage	1/n/PE ~ 230 V 50 Hz
Protection category	IP X8

(must only be connected by qualified electricians)

**i** Cement based plaster, cement based fillers or emulsion sgraffito can be applied. In case of thin-layer plaster, the glass fibre mesh makes it necessary to coat the lounger in advance so that the mesh cannot be seen through the plaster. For all applied products the processing instructions of the manufacturer should be complied with.

When an electric heating is used, the user must take care in order to prevent a heat build-up, e.g. caused by a stack of towels, from occurring.

# wedi Sanbath *Cube* & wedi Sanbath *Wave* | Bathtub

## General product description

---

wedi Sanbath bathtub is a pre-fabricated bathtub for individual tiling. Bespoke designs are also possible.

## Applications

---

For domestic and commercial use indoors in conjunction with tap and cleaning water.

## Product properties

---

- Waterproof
- Thermally insulating
- Stable and lightweight

## Surface requirements

---

The floor should have a sufficient load capacity and should be even.

## Form of delivery

---

- Bathtub element
- Bespoke designs possible
- Drain and overflow fittings with outlet supports DN 40/50
- Bowden cable with rotary button
- Substructure element
- Fundo Fino exclusive cover
- Fundo Fino elegant frame, stainless steel





## Technical properties – Rigid foam

Extruded polystyrene rigid foam core	XPS
Long-term compressive strength (50 years) $\leq$ 2% compression EN 1606	0.08 N/mm <sup>2</sup>
Compressive resistance at 10% compression EN 826	0.25 N/mm <sup>2</sup>
Thermal conductivity EN 13164	0.036 W/mK
Bulk density EN 1602	32 kg/m <sup>3</sup>
Temperature limits	-50°C / +75°C
Fire behaviour/Building material class DIN 4102	B1
Fire behaviour EN 13501-1	E

## Technical properties – Drain and overflow fittings

Sealed, built-in drain and overflow fittings

Overflow capacity	up to 0.6 l/s ; 36 l/min
Drain capacity	up to 1.0 l/s ; 60 l/min
Water level	355 mm

## Sanbath *Cube* & Sanbath *Wave* | Bathtub

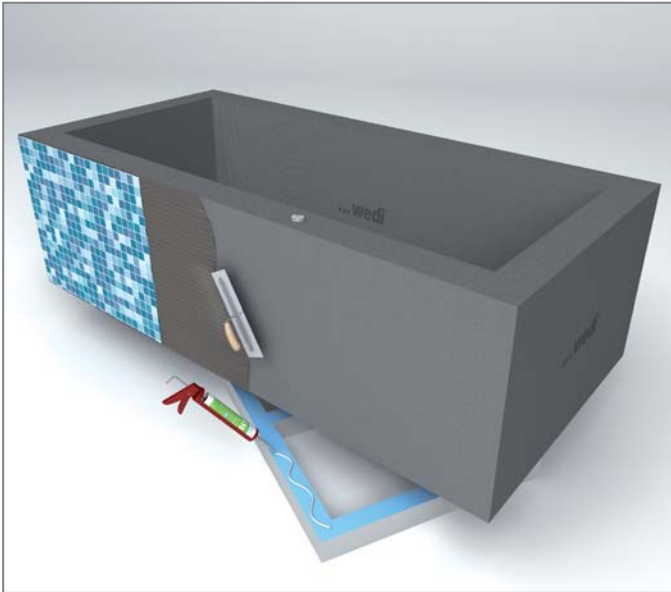

The wedi design series Sanbath is the easiest way to bring new shapes and colours into the bathroom. wedi Sanbath Cube and Sanbath Wave are ready-for-assembly bathtubs made of the wedi building board material. After installation and connection, the desired tiling surface can be installed – the bathtub is ready for use.



### wedi system components:

- Sanbath *Cube/Wave* bathtub

- wedi 610 adhesive sealant

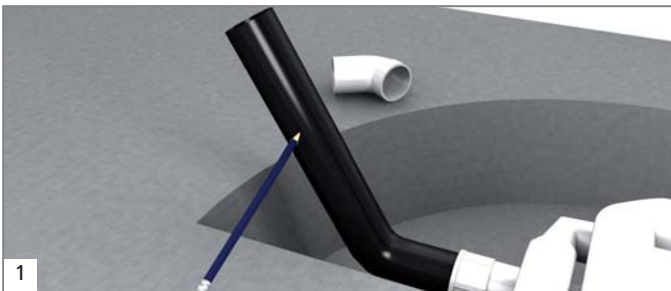

1 Connect the supply line and mark at the outer edge of the curvature.



2 Cut tube to size by using the hack saw.

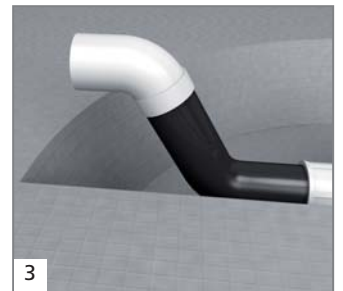

3 Install elbow.

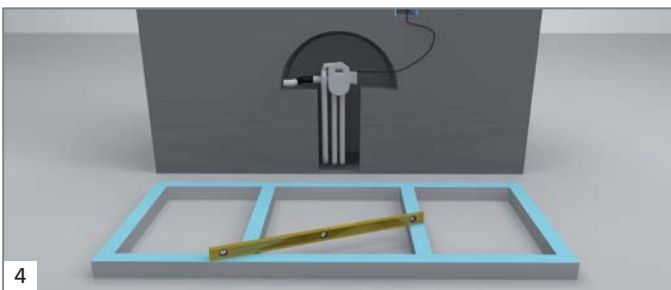

4 Check whether the screed is level; adjust tub substructure by using mortar, if applicable.

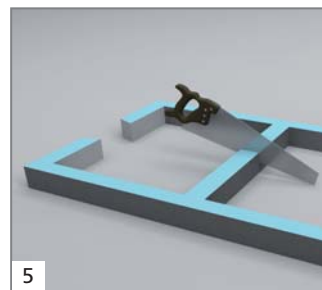

5 Cut inspection opening and slot for laying the connection lines in the tub substructure.

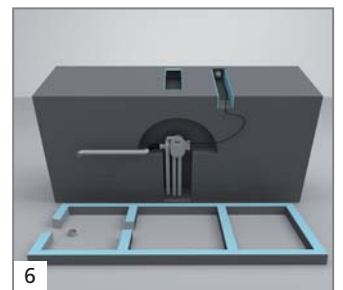

6 Place tub onto substructure and check wastewater duct via the inspection opening (functional check).

**!** Final positioning of tub with consideration of the desired position of the rotary button. If the rotary button is to be positioned directly at a wall, the Bowden cable should be installed before installing the tub as described in section 9.

## Continuation of installation steps

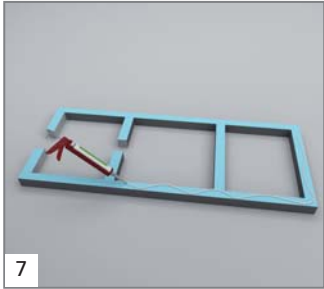

7  
Bond substructure to the floor and apply adhesive for the tub.

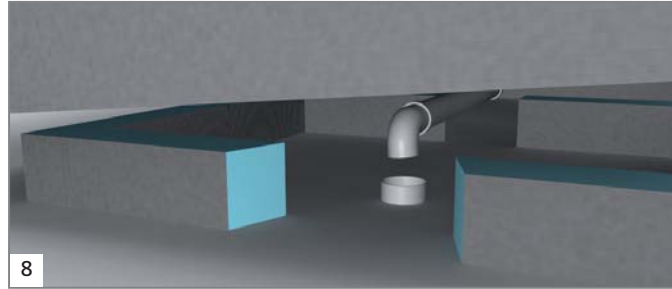

8  
Now, bond the tub to the substructure element. Tightly connect wastewater pipe (tightness check). Close and/or insert inspection opening in socket area.

**!** The inspection opening can only be closed after tiling of tub edge and installation of Bowden cable. Then, the tub walls can be tiled.

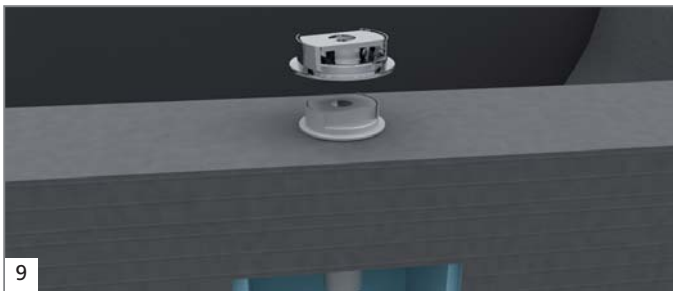

9  
Tiling of tub edge requires removal of the rotary button. For this, turn the rotary button in the inspection opening fully to the right as far as it will go, and then press the brass element out of the frame. Then, turn the rotary button to the left until the ball of the Bowden cable shows up. The ball can now be pulled out.

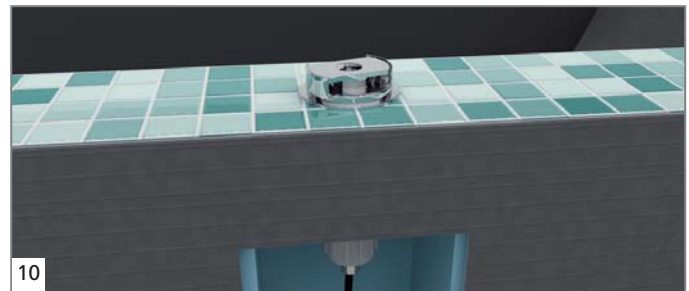

10  
Install the Bowden cable after tiling. For this, place the plastic thread into the hole, tighten the counter nut, and install the Bowden cable as stated in section 9 (functional check). Apply wedi 610 adhesive sealant onto the overlap and install inspection opening cover.

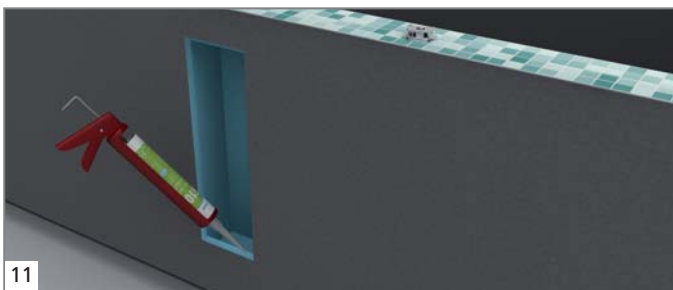

11  
There is a factory-side installation well to enable installation of water supply and/or installation of tub edge fittings by the customer. The well is closed and/or sealed with the enclosed inspection opening cover.

**!** Important information:

If the fittings are to be installed on the tub edge, a reinforcement board should be previously installed.

## Sanbath *Cube* | Washbasin



wedi Sanbath Cube is a complete washbasin with cubist shape for a great design in every bathroom. Depending on your personal taste, it can receive various tiled finishes.

### wedi system components:

- Sanbath *Cube* washbasin
- wedi *Tools* sealing tape
- wedi 610 adhesive sealant

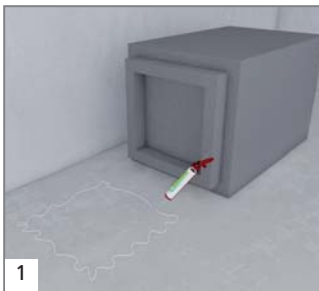

1

Application of wedi 610 adhesive sealant at the respective location. Then, bond the washbasin to the floor.

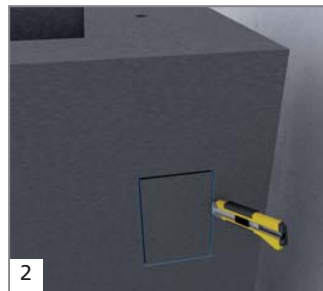

2

Make a tapered cut to the inspection opening by using a utility knife.



3

Except for the area of the inspection opening, the whole washbasin can be tiled.



4

Application of fittings at the correspondingly reinforced location. Connection is made via the inspection opening.



5

Then, close the inspection opening and tile.

## Sanbath *Cube* & Sanbath *Wave* | Shower column

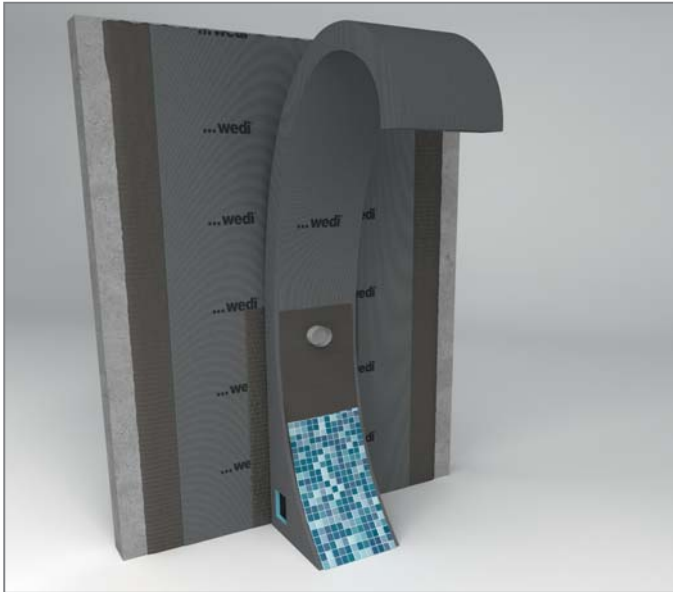

The wedi Sanbath Cube shower column provides a clear design with elegant simplicity. Sanbath Wave is a wave-shaped shower column and provides of an integrated Hansgrohe iBox for installation of hand and head showers. The following installation, uses Sanbath Wave as an example.

### wedi system components:

- Sanbath *Cube/Wave* shower column
- wedi *Tools* sealing tape
- wedi 610 adhesive sealant



1 Place wedi shower column. Ensure correct positioning of connections.

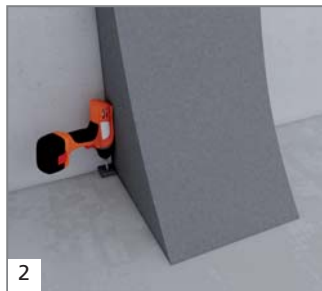

2 Fasten the shower column to the floor by using screws.

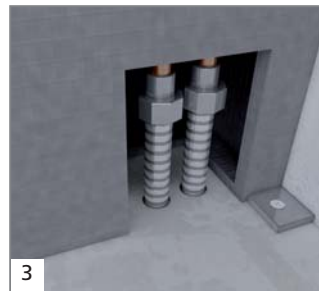

3 Connect the lines via the inspection opening. Then, close the inspection opening.



4 Finally, tile the shower column.

## wedi *Eterua* | Glass door with stainless steel door frame

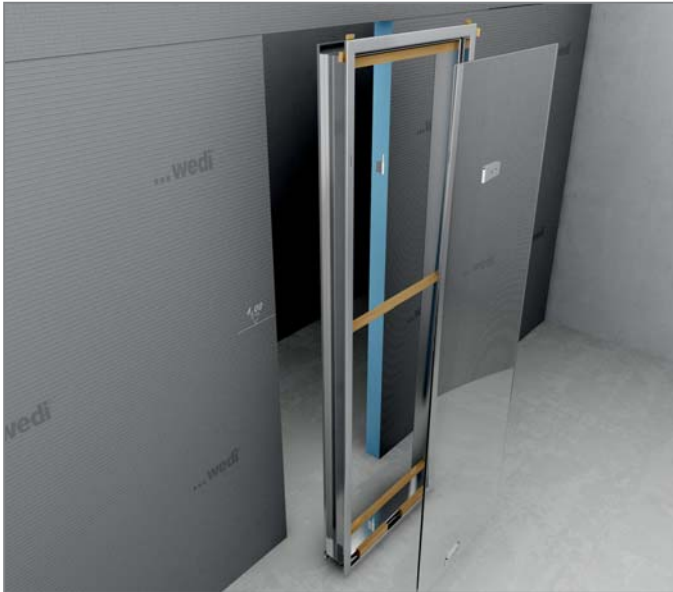

The wedi glass doors are equipped with stainless steel frames and offer a clear view to bathroom and wellness area. Whether for wedi wellness projects or other areas – the various options ensure a versatile use.

### wedi system components:

- wedi *Eterua* glass door
- wedi *Tools* sealing tape
- wedi 610 adhesive sealant



1 Install frame into wall opening and set height (setting-out) and adjust by using wooden wedges.

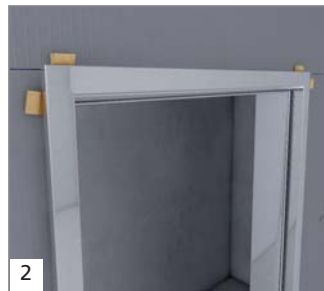

2 Fasten to the wall by using wedges at the four corners of the top frame; ensure identical distance between wall and frame.

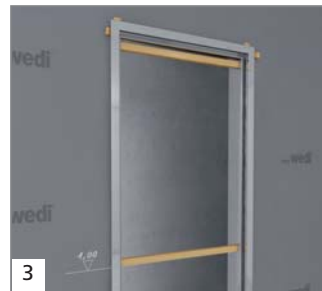

3 Measure rebate width at top part. Cut spacer boards to size, and secure frame distance at the top, in the middle and on the bottom.

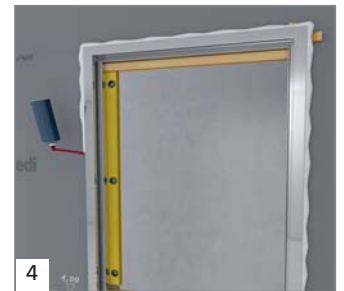

4 Check position of frame by using a spirit level, and correct, if required. Then, apply PU foam into the spaces between the frame and the board, cutting off any escaping foam after drying.

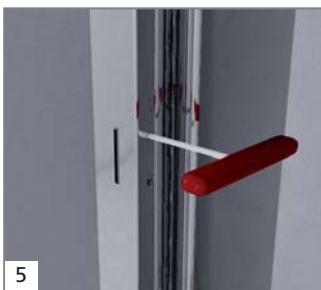

5 Break plastic cover of clamping screw and loosen the screw located behind.



6 Assemble and install hinge, and secure it by using clamping screws.



7 Install, adjust and fasten glass door in the frame by placing it on top of blocks or wedges.

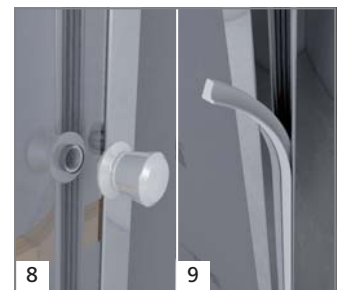

8 Install door knob and insert frame rubber.

### Please note:

Dimensions of clear opening:

Width: width of stainless steel frame + approx. 39 mm

Height: height of stainless steel frame + approx. 47 mm

# Care instructions

## Care instructions for stainless steel

---

Cleaning means removal of foreign objects from the surfaces. Given regular cleaning and care, stainless steel surfaces will maintain their appearance.

Impurities such as sand, dust, dried residues of drinks and food can be dissolved by using aqueous cleaning agents. Then, wipe off the dirt by using a wet cloth. Fats and oils are dissolved by using, alkaline or acidic cleaning agents.

Use special stainless steel cleaners in accordance with their respective instructions. When cleaning stainless steel, do not use steel wool or steel brushes as the corresponding abrasion material may result in rust forming. All cleaning agents should be free of hydrochloric acid and chlorine.

Occasionally occurring foreign rust originating from other rusted parts or air should be immediately removed by wiping off or by using a non-abrasive cleaning agent. Hardly soluble residues or minor scratches can be removed by using a plastic fibre fleece or sand paper suitable for stainless steel (min. grain size 280). Please note: always rub into the direction of the rubbing pattern already present – never rub diagonally to such pattern!

Preventative actions: aerosols rich in salts are highly aggressive; this particularly applies when there are high salt concentration on surfaces due to evaporation and the surface is not or only occasionally washed e.g. by rain. Depositing of solids such as soot resulting from improperly combusted oil usually results in accelerated corrosion.

## Care instructions for Fundo floor elements

---

### Stainless steel grate

With regular use and care, stainless steel will maintain its very appealing appearance. Impurities such as sand and soap residues can be dissolved by using aqueous cleaning agents. Then, wipe off the dirt by using a wet cloth. Fats and oils are dissolved by using, alkaline or acidic cleaning agents.





Occasionally occurring foreign rust can be removed by using stainless steel cleaning agent in accordance with the corresponding instructions.





When cleaning stainless steel, no steel wool or steel brushes should be used.

### Hair trap and drain

Depending on the use, the hair trap should be removed and cleaned with clean water every 6 – 8 weeks. After installation, the air trap should be filled with water. The drain is made of high-quality plastics and, depending on use, should be cleaned with clear water every 6 – 8 weeks.



-  wedi building board systems
-  wedi floor-level showers
-  wedi design elements
-  wedi sealing and decoupling

-  wedi wellness projects
-  wedi system chemistry
-  wedi practical auxiliaries
-  wedi support



wedi GmbH  
Hollefeldstraße 51 · 48282 Emsdetten · Germany  
Telephone +49 2572 156-0 · Fax +49 2572 156-133  
info@wedi.de · www.wedi.eu

